

Data Projector

Operating Instructions

Before operating the unit, please read this manual thoroughly and retain it for future reference.

VPL-DX10/DX11/DX15

Not all models are available in all countries and area. Please check with your local Sony Authorized Dealer.

WARNING

To reduce the risk of fire or electric shock, do not expose this apparatus to rain or moisture.

To avoid electrical shock, do not open the cabinet. Refer servicing to qualified personnel only.

**WARNING
THIS APPARATUS MUST BE
EARTHED.**

WARNING

When installing the unit, incorporate a readily accessible disconnect device in the fixed wiring, or connect the power plug to an easily accessible socket-outlet near the unit. If a fault should occur during operation of the unit, operate the disconnect device to switch the power supply off, or disconnect the power plug.

Notice for customers

The statements for each country/area are only applicable to equipment sold in that country/area.

WARNING: THIS WARNING IS APPLICABLE FOR USA ONLY.
If used in USA, use the UL LISTED power cord specified below.
DO NOT USE ANY OTHER POWER CORD.

Plug Cap	Parallel blade with ground pin (NEMA 5-15P Configuration)
Cord	Type SVT, three 18 AWG wires
Length	Minimum 1.5 m (4 ft .1 in.), Less than 2.4 m (7 ft .9 in.)
Rating	Minimum 7 A, 125 V

Using this unit at a voltage other than 120V may require the use of a different line cord or attachment plug, or both.

To reduce the risk of fire or electric shock, refer servicing to qualified service personnel.

WARNING: THIS WARNING IS APPLICABLE FOR OTHER COUNTRIES.

- 1 Use the approved Power Cord (3-core mains lead) / Appliance Connector / Plug with earthing-contacts that conforms to the safety regulations of each country if applicable.
- 2 Use the Power Cord (3-core mains lead) / Appliance Connector / Plug conforming to the proper ratings (Voltage, Ampere).

If you have questions on the use of the above Power Cord / Appliance Connector / Plug, please consult a qualified service personnel.

IMPORTANT

The nameplate is located on the bottom.

For kundene i Norge

Dette utstyret kan kobles til et IT-strømfordelingssystem.

For the customers in the U.S.A.

This equipment has been tested and found to comply with the limits for a Class B digital device, pursuant to Part 15 of the FCC Rules. These limits are designed to provide reasonable protection against harmful interference in a residential installation. This equipment generates, uses, and can radiate radio frequency energy and, if not installed and used in accordance with the instructions, may cause harmful interference to radio communications. However, there is no guarantee that interference will not occur in a particular installation. If this equipment does cause harmful interference to radio or television reception, which can be determined by turning the equipment off and on, the user is encouraged to try to correct the interference by one or more of the following measures:

- Reorient or relocate the receiving antenna.
- Increase the separation between the equipment and receiver.
- Connect the equipment into an outlet on a circuit different from that to which the receiver is connected.
- Consult the dealer or an experienced radio/TV technician for help.

You are cautioned that any changes or modifications not expressly approved in this manual could void your authority to operate this equipment.

All interface cables used to connect peripherals must be shielded in order to comply with the limits for a digital device pursuant to Subpart B of Part 15 of FCC Rules.

This device complies with Part 15 of the FCC Rules. Operation is subject to the following two conditions: (1) this device may not cause harmful interference, and (2) this device must accept any interference received, including interference that may cause undesired operation.

If you have any questions about this product, you may call;

*Sony Customer Information Service Center
1-800-222-7669 or <http://www.sony.com/>*

Declaration of Conformity

Trade Name: SONY
Model: VPL-DX10
VPL-DX11
VPL-DX15
Responsible party:
Sony Electronics Inc.
Address: 16530 Via Esprillo, San
Diego, CA 92127U.S.A.
Telephone Number:
858-942-2230

This device complies with part 15 of the FCC Rules. Operation is subject to the following two conditions: (1) this device may not cause harmful interference, and (2) this device must accept any interference received, including interference that may cause undesired operation.

For the customers in Canada

This Class B digital apparatus complies with Canadian ICES-003.

For the customers in Europe

The manufacturer of this product is Sony Corporation, 1-7-1 Konan, Minato-ku, Tokyo, Japan.

The Authorized Representative for EMC and product safety is Sony Deutschland GmbH, Hedelfinger Strasse 61, 70327

Stuttgart, Germany. For any service or guarantee matters please refer to the addresses given in separate service or guarantee documents.

For the State of California, USA only

Perchlorate Material - special handling may apply, See

www.dtsc.ca.gov/hazardouswaste/perchlorate

Perchlorate Material: Lithium battery contains perchlorate.

Disposal of the used lamp

For the customers in the USA

Lamp in this product contains mercury. Disposal of these materials may be regulated due to environmental considerations. For disposal or recycling information, please contact your local authorities or the Electronic Industries Alliance (www.eiae.org).

For the customers in Taiwan only



廢電池請回收

For VPL-DX15 only

For the customers in the U.S. A. and Canada

This device complies with Part 15 of FCC Rules and RSS-Gen of IC Rules. Operation is subject to the following two conditions: (1) this device may not cause interference, and (2) this device must accept any interference, including interference that may cause undesired operation of this device.

This equipment complies with FCC/IC radiation exposure limits set forth for uncontrolled equipment and meets the FCC radio frequency (RF) Exposure Guidelines in Supplement C to OET65 and RSS-102 of

the IC radio frequency (RF) Exposure rules. This equipment should be installed and operated with at least 20cm and more between the radiator and person's body (excluding extremities: hands, wrists, feet and ankles).

For the customers in the U.S.A.

In according with 47 CFR Part15.407 (e) U-NII devices operating in 5.15-5.25GHz frequency bands are restricted to indoor operations only.

This transmitter must not be co-located or operated in conjunction with any other antenna or transmitter.

For the customers in Europe

Notice for customers: the following information is only applicable to equipment sold in Countries applying EU directives.



This product is intended to be used in the following countries:

AT	BE	BG	CY	CZ	DK	EE	FI	FR	DE	GR
HU	IE	IT	LV	LT	LU	MT	NL	PL	PT	RO
SK	SI	ES	SE	GB	IS	LI	NO	CH		

Bulgarian	С настоящето Сони Корпорация декларира, че този VPL-DX15/Data Projector отговаря на основните изисквания и другите съответстващи клаузи на Директива 1999/5/ЕС. Подробности може да намерите на Интернет страницата : http://www.compliance.sony.de/ .
Czech	Sony Corporation tímto prohlašuje, že tento VPL-DX15/Data Projector je ve shodě se základními požadavky a dalšími příslušnými ustanoveními směrnice 1999/5/ES. Podrobnosti lze získat na následující URL: http://www.compliance.sony.de/
Danish	Undertegnede Sony Corporation erklærer herved, at følgende udstyr VPL-DX15/Data Projector overholder de væsentlige krav og øvrige relevante krav i direktiv 1999/5/EF. For yderligere information gå ind på følgende hjemmeside: http://www.compliance.sony.de/
Dutch	Hierbij verklaart Sony Corporation dat het toestel VPL-DX15/Data Projector in overeenstemming is met de essentiële eisen en de andere relevante bepalingen van richtlijn 1999/5/EG. Nadere informatie kunt u vinden op: http://www.compliance.sony.de/
English	Hereby, Sony Corporation, declares that this VPL-DX15/Data Projector is in compliance with the essential requirements and other relevant provisions of Directive 1999/5/EC. For details, please access the following URL: http://www.compliance.sony.de/

Estonian	Sony Corporation kinnitab käesolevaga seadme VPL-DX15/Data Projector vastavust 1999/5/EÜ direktiivi põhinõuetele ja nimetatud direktiivist tulenevatele teistele asjakohastele sätetele. Üksikasjalikum info: http://www.compliance.sony.de/ .
Finnish	Sony Corporation vakuuttaa täten että VPL-DX15/Data Projector tyyppinen laite on direktiivin 1999/5/EY oleellisten vaatimusten ja sitä koskevien direktiivin muiden ehtojen mukainen. Halutessasi lisätietoja, käy osoitteessa: http://www.compliance.sony.de/
French	Par la présente Sony Corporation déclare que l'appareil VPL-DX15/Data Projector est conforme aux exigences essentielles et aux autres dispositions pertinentes de la directive 1999/5/CE. Pour toute information complémentaire, veuillez consulter l'URL suivante: http://www.compliance.sony.de/
German	Hiermit erklärt Sony Corporation, dass sich das Gerät VPL-DX15/Data Projector in Übereinstimmung mit den grundlegenden Anforderungen und den übrigen einschlägigen Bestimmungen der Richtlinie 1999/5/EG befindet. Weitere Informationen erhältlich unter: http://www.compliance.sony.de/
Greek	Με την παρούσα η Sony Corporation δηλώνει ότι VPL-DX15/Data Projector συμμορφώνεται προς της ουσιώδεις απαιτήσεις και τις λοιπές σχετικές διατάξεις της οδηγίας 1999/5/EK. Για λεπτομέρειες παρακαλούμε όπως ελέγξετε την ακόλουθη σελίδα του διαδικτύου: http://www.compliance.sony.de/
Hungarian	Alulírott, Sony Corporation nyilatkozom, hogy a(z) VPL-DX15/Data Projector megfelel a vonatkozó alapvető követelményeknek és az 1999/5/EC irányelv egyéb előírásainak. További információkat a következő weboldalon találhat: http://www.compliance.sony.de/
Italian	Con la presente Sony Corporation dichiara che questo VPL-DX15/Data Projector è conforme ai requisiti essenziali ed alle altre disposizioni pertinenti stabilite dalla direttiva 1999/5/CE. Per ulteriori dettagli, si prega di consultare il seguente URL: http://www.compliance.sony.de/
Latvian	Ar šo Sony Corporation deklarē, ka VPL-DX15/Data Projector atbilst Direktīvas 1999/5/EK būtiskajām prasībām un citiem ar to saistītajiem noteikumiem. Plašāka informācija ir pieejama: http://www.compliance.sony.de/
Lithuanian	Šiuo Sony Corporation deklaruoja, kad šis VPL-DX15/Data Projector atitinka esminius reikalavimus ir kitas 1999/5/EB Direktyvos nuostatas. Susipažinti su visu atitikties deklaracijos turiniu Jūs galite interneto tinklalapyje: http://www.compliance.sony.de/
Norwegian	Sony Corporation erklærer herved at utstyret VPL-DX15/Data Projector er i samsvar med de grunnleggende krav og øvrige relevante krav i direktiv 1999/5/EF. For flere detaljer, vennligst se: http://www.compliance.sony.de/
Polish	Niniejszym Sony Corporation oświadcza, że VPL-DX15/Data Projector jest zgodne z zasadniczymi wymaganiami oraz innymi stosownymi postanowieniami Dyrektywy 1999/5/WE. Szczegółowe informacje znaleźć można pod następującym adresem URL: http://www.compliance.sony.de/
Portuguese	Sony Corporation declara que este VPL-DX15/Data Projector está conforme os requisitos essenciais e outras disposições da Directiva 1999/5/CE. Para mais informacoes, por favor consulte a seguinte URL: http://www.compliance.sony.de/

Romanian	Prin prezenta, Sony Corporation declară că acest VPL-DX15/Data Projector respectă cerințele esențiale șieste în conformitate cu prevederile Directivei 1999/5/EC. Pentru detalii, vă rugăm accesați următoarea adresă: http://www.compliance.sony.de/
Slovak	Sony Corporation týmto vyhlasuje, že VPL-DX15/Data Projector splňa základné požiadavky a všetky príslušné ustanovenia Smernice 1999/5/ES. Podrobnosti získate na nasledovnej webovej adrese: http://www.compliance.sony.de/
Slovenian	Sony Corporation izjavlja, da je ta VPL-DX15/Data Projector v skladu z bistvenimi zahtevami in ostalimi relevantnimi določili direktive 1999/5/ES. Za podrobnosti vas naprošamo, če pogledate na URL: http://www.compliance.sony.de/
Spanish	Por medio de la presente Sony Corporation declara que el VPL-DX15/Data Projector cumple con los requisitos esenciales y cualesquiera otras disposiciones aplicables o exigibles de la Directiva 1999/5/CE. Para mayor información, por favor consulte el siguiente URL: http://www.compliance.sony.de/
Swedish	Härmed intygar Sony Corporation att denna VPL-DX15/Data Projector står i överensstämmelse med de väsentliga egenskapskrav och övriga relevanta bestämmelser som framgår av direktiv 1999/5/EG. För ytterligare information gå in på följande hemsida: http://www.compliance.sony.de/

For the customers in France

The WLAN feature of this Data Projector shall exclusively be used inside buildings.

For the customers in Italy

Use of the RLAN network is governed:

- with respect to private use, by the Legislative Decree of 1.8.2003, no. 259 (“Code of Electronic Communications”). In particular Article 104 indicates when the prior obtainment of a general authorization is required and Art. 105 indicates when free use is permitted;
- with respect to the supply to the public of the RLAN access to telecom networks and services, by the Ministerial Decree 28.5.2003, as amended, and Art. 25 (general authorization for electronic communications networks and services) of the Code of electronic communications
- with respect to private use, by the Ministerial Decree 12.07.2007

For the customers in Cyprus

The end user must register the RLAN devices in the Department of Electronic Communications (P.I. 6/2006 and P.I. 6A/2006).

P.I. 6/2006 is the Radiocommunications (Categories of Stations Subject to General Authorization and Registration) Order of 2006.

P.I. 6A/2006 is the General Authorization for the use of Radiofrequencies by Radio Local area Networks and by Wireless Access Systems, including Radio Local Area Networks (WAS/RLAN).

Για τους πελάτες στην Κύπρο

Ο τελικός χρήστης πρέπει να εγγράψει τις συσκευές RLAN στο Τμήμα Ηλεκτρονικών Επικοινωνιών (ΚΔΠ. 6/2006 και ΚΔΠ. 6Α/2006).

Το ΚΔΠ. 6/2006 είναι το Διάταγμα περί Ραδιοεπικοινωνιών του 2006 (Κατηγορίες Ραδιοσυχνοτήτων Υποκείμενες σε Γενική Εξουσιοδότηση και Εγγραφή).

Το ΚΔΠ. 6Α/2006 αποτελεί τη Γενική Εξουσιοδότηση για τη χρήση ραδιοσυχνοτήτων από τοπικά ασύρματα δίκτυα και ασύρματα συστήματα πρόσβασης, συμπεριλαμβανομένων των τοπικών δικτύων επικοινωνιών (WAS/RLAN).

For the customers in Norway

Use of this radio equipment is not allowed in the geographical area within a radius of 20 km from the centre of Ny-Ålesund, Svalbard.

For kundene i Norge

Det er ikke tillatt å bruke dette radioutstyret innen en radius på 20 km fra sentrum av Ny-Ålesund, Svalbard.

For the customers in Taiwan

注意

經型式認證合格之低功率射頻電機，非經許可，公司、商號或使用者均不得擅自變更頻率、加大功率或變更原設計之特性及功能。

低功率射頻電機之使用不得影響飛航安全及干擾合法通信；經發現有干擾現象時，應立即停用，並改善至無干擾時方得繼續使用。前項合法通信，指依電信法規定作業之無線電通信。

低功率射頻電機須忍受合法通信或工業、科學及醫療用電波輻射性電機設備之干擾。

Table of Contents

Precautions	10
Notes on Installation and Usage	11
Unsuitable Installation	11
Usage in High Altitude	12
Unsuitable Conditions	13

Overview

About the Supplied Manuals	14
Included Attachments	15
Location and Function of Controls (Main Unit)	16
Top/Front/Side	16
Rear/Side/Bottom	16
Control Panel	18
Connector Panel	19
Remote Commander	20

Projecting the Picture

Installing the Projector	22
Connecting the Projector	22
Connecting a Computer	23
Connecting a VCR	24
Connecting to a Network (VPL-DX15 only)	25
Connecting a USB memory (VPL-DX15 only)	25
Projecting	25
Turning Off the Power	28

Convenient Functions

Selecting the Menu Language	29
Resetting All Setting Values	30

To Change from the Menu	30
To Return the Value of an Adjusted Item to Default	31
Correcting the Trapezoidal Distortion Automatically (Auto V Keystone Correction)	31
Further Adjusting an Image That Has Been Automatically Adjusted	31
To Change from the Menu	32
Switching off Smoothly after Presentation (Off & Go)	33
Using the Security Function	33
Security Lock (Password)	33
Panel Key Lock	35
Security Lock (Mechanical)	36
Using Various Functions During Projecting	36
Zoom a Part of the Image (Digital Zoom)	36
To Freeze the Image Projected (Freeze)	37
Pausing the Image	37
Lens Shutter (Recommended for Use on the Floor)	37
Picture Muting (Recommended for Use Suspend from a Ceiling)	38
Pausing the Sound (Audio Muting)	38
Adjusting the Image Quality (Smart APA)	39
Setting the Picture Mode	40
Starting the Network Function or the USB File Viewer With One Keypress (VPL-DX15 only)	41

Using the Network Function (VPL-DX15 only)	41
Projecting the File in the USB Memory Directly (VPL-DX15 only)	42

Adjustments and Settings Using a Menu

Using a MENU	43
The Picture Menu	45
The Screen Menu	47
About the Preset Memory No.	49
The Setup Menu	50
The Function Menu	52
The Installation Menu	54
The Network Setting Menu (VPL-DX15 only)	55
The Information Menu	56

Maintenance

Replacing the Lamp	58
Cleaning the Air Filter	60

Others

Troubleshooting	61
Messages List	65
Specifications	66
Installing the Projector and Installation Diagram	70
Floor Installation (Front Projection)	70
Ceiling Installation (Front Projection)	72
Dimensions	74
Index	77

Precautions

On safety

- Check that the operating voltage of your unit is identical with the voltage of your local power supply. If voltage adaptation is required, consult with qualified Sony personnel.
- Should any liquid or solid object fall into the cabinet, unplug the unit and have it checked by qualified Sony personnel before operating it further.
- Unplug the unit from the wall outlet if it is not to be used for several days.
- To disconnect the cord, pull it out by the plug. Never pull the cord itself.
- The wall outlet should be near the unit and easily accessible.
- The unit is not disconnected from the AC power source (mains) as long as it is connected to the wall outlet, even if the unit itself has been turned off.
- Do not look into the lens while the lamp is on.
- Do not place your hand or objects near the ventilation holes (exhaust) — the air coming out is hot.
- Be careful not to catch your fingers by the adjuster when you adjust the height of the unit. Do not push hard on the top of the unit with the adjuster out.
- Be sure to grasp both sides of the unit with both hands when carrying the unit.

On illumination

- To obtain the best picture, the front of the screen should not be exposed to direct lighting or sunlight.
- Cover any windows that face the screen with opaque draperies.
- It is desirable to install the unit in a room where floor and walls are not of light-reflecting material. If the floor and walls are of reflecting material, it is recommended that the carpet and wall paper be changed to a dark color.

On preventing internal heat build-up

The unit is equipped with ventilation holes (intake) at the bottom and ventilation holes (exhaust) at the side. Do not block or place anything near these holes, or internal heat build-up may occur, causing picture degradation or damage to the unit.

On cleaning

Before cleaning

Be sure to disconnect the AC power cord from the AC outlet.

On cleaning the air filter

- Clean the air filter whenever you replace the lamp.
- Refer to the “Cleaning the Air Filter” on page 60 for the air filter cleaning.

On cleaning the lens

The lens surface is especially treated to reduce reflection of light.

As incorrect maintenance may impair the performance of the projector, take care with respect to the following:

- Avoid touching the lens. To remove dust on the lens, use a soft dry cloth. Do not use a damp cloth, detergent solution, or thinner.
- Wipe the lens gently with a soft cloth such as a cleaning cloth or glass cleaning cloth.
- Stubborn stains may be removed with a soft cloth such as a cleaning cloth or glass cleaning cloth lightly dampened with water.
- Never use solvent such as alcohol, benzene or thinner, or acid, alkaline or abrasive detergent, or chemical cleaning cloth, as they will damage the lens surface.

On cleaning the cabinet

- Clean the cabinet gently with a soft dry cloth. Stubborn stains may be removed with a cloth lightly dampened with mild detergent solution, followed by wiping with a soft dry cloth.
- Use of alcohol, benzene, thinner or insecticide may damage the finish of the cabinet or remove the indications on the cabinet. Do not use these chemicals.

- If you rub on the cabinet with a stained cloth, the cabinet may be scratched.
- If the cabinet is in contact with a rubber or vinyl resin product for a long period of time, the finish of the cabinet may deteriorate or the coating may come off.

On LCD projector

The LCD projector is manufactured using high-precision technology. You may, however, see tiny black points and/or bright points (red, blue, or green) that continuously appear on the LCD projector. This is a normal result of the manufacturing process and does not indicate a malfunction. Also, when you use multiple LCD projectors to project onto a screen, even if they are of the same model, the color reproduction among projectors may vary, since color balance may be set differently from one projector to the next.

Notes on Installation and Usage

Unsuitable Installation

Do not install the unit in the following situations. **These installations may cause malfunction or damage** to the unit.

Poorly ventilated

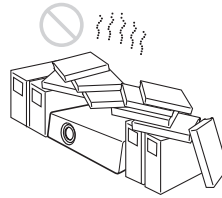

- Allow adequate air circulation to prevent internal heat build-up. Do not place the unit on surfaces (rugs, blankets, etc.) or near materials (curtains, draperies) that may block the ventilation holes.
- When the internal heat builds up due to the block-up, the temperature sensor will function with the message “High temp.! Lamp off in 1 min.” The power will be turned off automatically after one minute.
- Leave space of more than 30 cm (11 ⁷/₈ inches) around the unit.
- Be careful that the ventilation holes may inhale tininess such as a piece of paper.

Highly heated and humid



- Avoid installing the unit in a location where the temperature or humidity is very high, or temperature is very low.
- To avoid moisture condensation, do not install the unit in a location where the temperature may rise rapidly.

Subject to direct cool or warm air from an air-conditioner

Installing in such a location may cause malfunction of the unit due to moisture condensation or rise in temperature.

Near a heat or smoke sensor

Malfunction of the sensor may be caused.

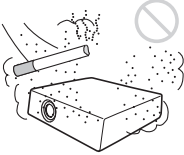
Very dusty, extremely smoky

Avoid installing the unit in a very dusty or extremely smoky environment. Otherwise, the air filter will become obstructed, and this may cause a malfunction of the unit or damage it. Dust preventing the air passing through the filter may cause a rise in the internal temperature of the unit. Clean the air filter whenever you replace the lamp.

Usage in High Altitude

When using the unit at an altitude of 1,500 m or higher, set the “High Altitude Mode” to “On” in the Setup menu. Failing to set this mode when using the unit at high altitudes could have adverse effects, such as reducing the reliability of certain components.

Note on the screen

When using a screen with an uneven surface, stripes pattern may rarely appear on the screen depending on the distance between the screen and the unit or the zooming magnifications. This is not a malfunction of the unit.

Unsuitable Conditions

Do not use the unit under the following conditions.

Do not topple the unit

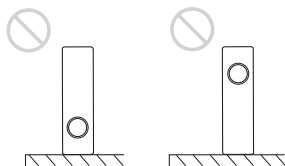

Avoid using as the unit topples over on its side. It may cause malfunction.

Do not tilt right/left

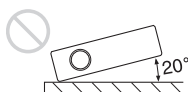

Avoid using as the unit tilts right or left more than 20 degrees. These installations may cause malfunction.

Do not block the ventilation holes



Avoid using something to cover over the ventilation holes (exhaust/intake); otherwise, the internal heat may build up.

Do not place a blocking object just in front of the lens

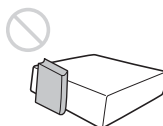

Do not place any object just in front of the lens that may block the light during projection. Heat from the light may damage the object. Use the picture muting function key to cut off the picture.

About the Supplied Manuals

The following manuals are supplied with the projector.

Manuals

Safety Regulations (separately printed manual)

This manual describes important notes and cautions to which you have to pay attention when handling and using this projector.

Quick Reference Manual (separately printed manual)

This manual describes basic operations for projecting pictures after you have made the required connections.

Operating Instructions (on the CD-ROM) (this manual)

This Operating Instructions describes the setup and operations of this projector.

Operating Instructions for Network/USB file Viewer (VPL-DX15 only) (on the CD-ROM)

This Operating Instructions describes about the network function and how to use the USB file viewer.

Note

You must have Adobe Acrobat Reader 5.0 or higher installed to read the Operating Instructions stored on the CD-ROM.

<p>This manual contains explanations for the VPL-DX10, VPL-DX11 and VPL-DX15 together. Be aware that the VPL-DX15 is mainly used for explanation of the display, and there may be an item that is not displayed due to the model.</p>

Included Attachments

The package for this product includes the Main unit (projector) and the following attachments. Check them before use.

Main unit (projector) (1)

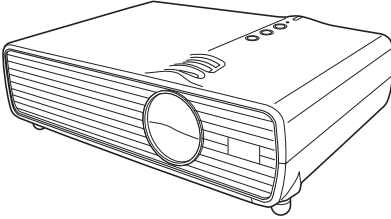

RM-PJ6 Remote Commander (1)

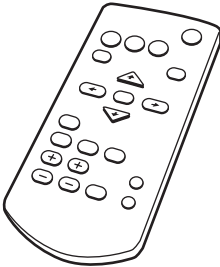

HD D-sub 15 pin cable (2 m) (1) (1-791-992-51/Sony)

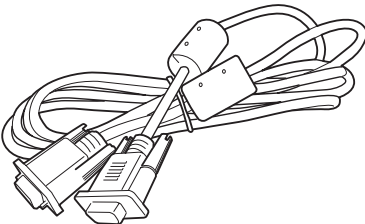

Carrying case (1)

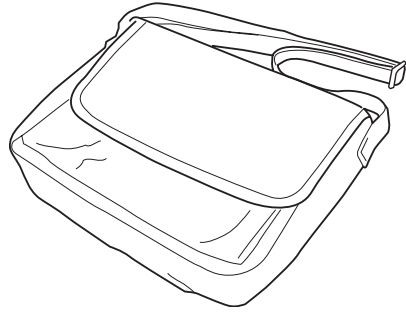

CR2025 Lithium battery (1) (installed in the Remote Commander)
AC power cord (1)
Operating Instructions (CD-ROM) (1)
Quick Reference Manual (1)
Safety Regulations (1)
Security Label (1)

Location and Function of Controls (Main Unit)

Top/Front/Side

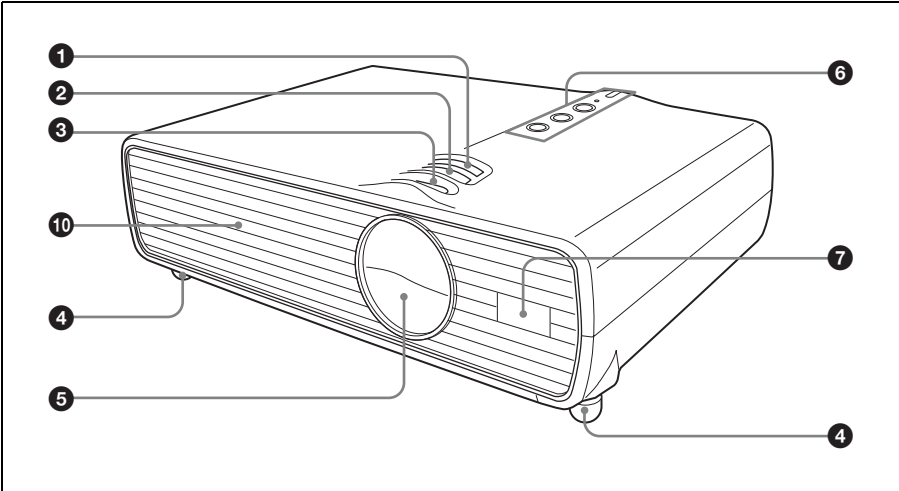

Rear/Side/Bottom

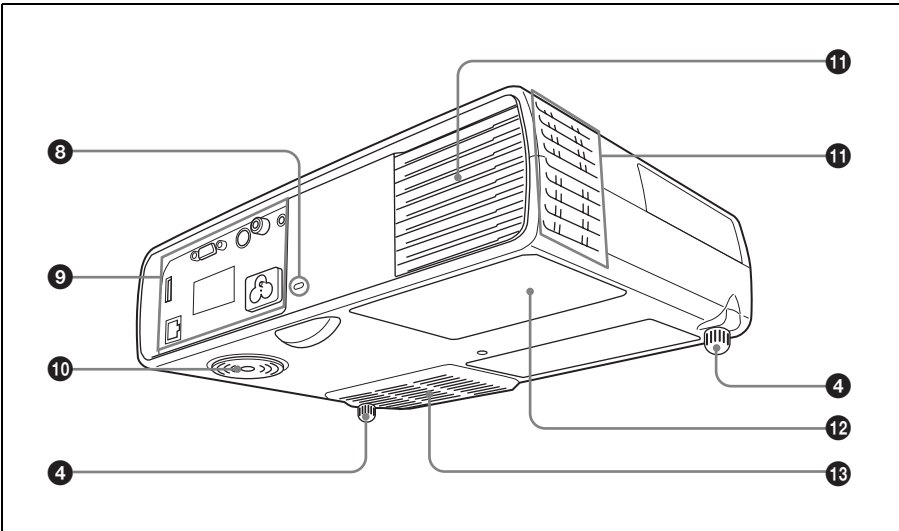

1 Zoom ring

Adjusts the picture size.

2 Focus ring

Adjusts the picture focus.

③ Lens shutter lever

If you operate the Lens shutter lever manually, the image is interrupted. In this case, the video signal is not projected to the screen.

④ Adjusters (front pad)

Use the adjusters for minor tilt adjustment of the projected picture.

For details, see “Using the adjuster” on page 26.

⑤ Lens/Lens shutter

⑥ Control Panel

For details, see “Control Panel” on page 18.

⑦ Remote control detector

⑧ Security lock

Connects to an optional security cable (from Kensington).

For details, see “Security Lock (Mechanical)” on page 36.

⑨ Connector Panel

For details, see “Connector Panel” on page 19.

⑩ Ventilation holes (intake)

⑪ Ventilation holes (exhaust)

⑫ Lamp cover

⑬ Ventilation holes (intake)/Air filter cover

Notes on ventilation holes

- Do not place anything near the ventilation holes as this may cause internal heat build-up.
- Do not place your hand near the ventilation holes and the circumference as this may cause injury.
- To maintain optimal performance, **clean the air filter every 500 hours.**

For details, see “Cleaning the Air Filter” on page 60.

Control Panel

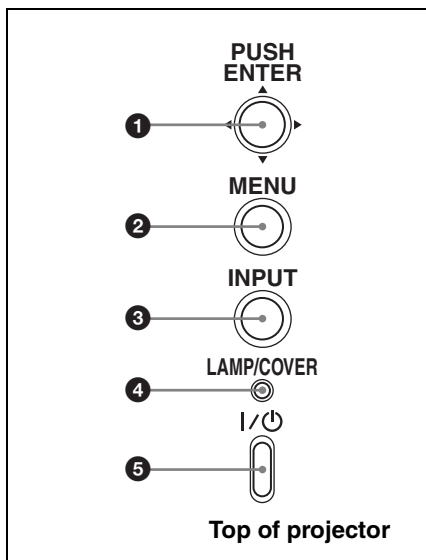

1 PUSH ENTER/▲/▼/◀/▶ (Arrow) keys

Used to enter the settings of items in the menu system, select a menu, or make various adjustments.

2 MENU key

Displays the on-screen menu. Press again to clear the menu.

3 INPUT key

Select the input signal. Each time you press the key the input signal switches.

4 LAMP/COVER indicator

Flashes in orange under the following conditions:

- A repetition rate of 2 flashes when the lamp cover is not secured firmly.
- A repetition rate of 3 flashes when the lamp has reached the end of its life or reaches a high temperature.

For details, see page 64.

5 I/⏻ (On/Standby) key

Turns on the projector when it is in standby mode. When you press I/⏻ key, this key flashes in green and then lights

in green when the projector is ready to operate.

To turn off the power, press the I/⏻ key twice according to the message or hold the I/⏻ key for about two seconds.

I/⏻ key lights up or flashes under the following conditions:

- Lights in red when the AC power cord is plugged into a wall outlet. Once the projector is in standby mode, you can turn it on with the I/⏻ key.
- Flashes in red when the internal temperature is high or the electrical system has failed.
- Lights in green when the projector is turned on, and when it is ready to operate.
- Flashes in green from the time when the projector is turned on until the projector is ready to operate. Also, flashes in green while the cooling fan is running after the power is turned off with the I/⏻ key. The fan runs for about 90 seconds after the power is turned off (during cooling).
- Lights in orange when the power saving mode is on.

Connector Panel

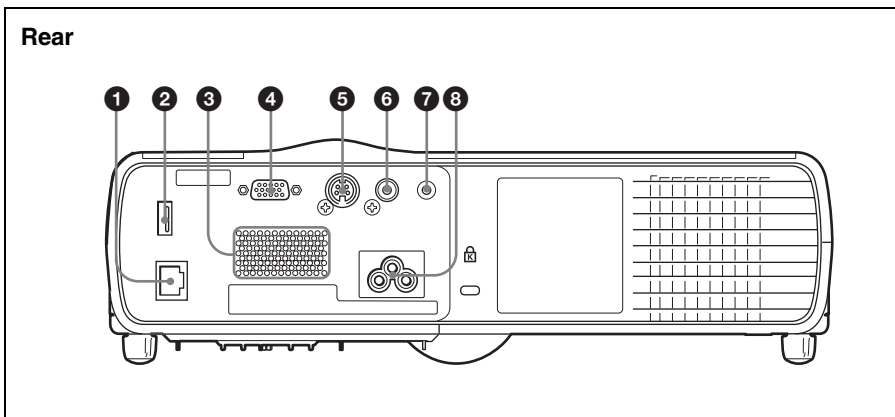

1  **(network) connector (RJ-45)**
(VPL-DX15 only)

Connects to the LAN cable when the network function is in use.

CAUTION

For safety, do not connect the connector for peripheral device wiring that might have excessive voltage to this port.

2  **(USB) connector (type A)**
(VPL-DX15 only)

Uses to view files saved on media with USB connection.

Note

The projector cannot be connected with the computer by connecting the USB cable to the USB connector on the projector.

3 **Speaker**

Outputs sound from signals input via the AUDIO terminals.

4 **INPUT A (Analog RGB) connector (HD D-sub 15-pin, female)**

Inputs a computer signal, video GBR signal, component signal, or DTV signal depending on the connected equipment. Connects to the output connector of equipment using the supplied cable or an optional cable.

For details, see “Connecting a Computer” on page 23 and “Connecting a VCR” on page 24.

5 **S VIDEO connector (mini DIN 4-pin)**

Connects to the S video output (Y/C video output) of video equipment.

6 **VIDEO connector (phono type)**

Connects to the composite video output of video equipment.

7 **AUDIO connector**

Connects to the audio output of video equipment.

8 **AC IN socket**

Connects the supplied AC power cord.

Remote Commander

The keys that have the same names as those on the control panel function identically.

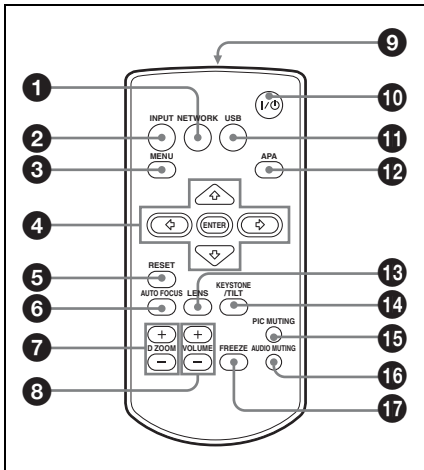

- 1 NETWORK key**
One press of this key starts the network function.
For details, refer to “Operating Instructions (For Network/USB File Viewer)” on the supplied CD-ROM.

Note

No key may function immediately after connecting the AC power cord, as the unit is starting up.

- 2 INPUT key**
- 3 MENU key**
- 4 ENTER/▲/▼/◀/▶ (Arrow) keys**
- 5 RESET key**
Use this to reset the menu, to restore the default value for the adjusted item, and others. Use it also for the digital zoom (page 36).
- 6 AUTO FOCUS key**
This function is not provided in this projector.

- 7 D ZOOM (Digital Zoom) +/- key**
Press this to activate the digital zoom
For details, see “Zoom a Part of the Image (Digital Zoom)” on page 36.

- 8 VOLUME +/- keys**
For adjusting the volume from the speakers.

- 9 Infrared transmitter**

- 10 I/O (On/Standby) key**

- 11 USB key**
One press of this key starts the USB file viewer function.

For details, refer to “Operating Instructions (For Network/USB File Viewer)” on the supplied CD-ROM.

Note

No key may function immediately after connecting the AC power cord, as the unit is starting up.

- 12 APA (Auto Pixel Alignment) key**
Executes APA.

For details, see “Adjusting the Image Quality (Smart APA)” on page 39.

- 13 LENS key**
This function is not provided in this projector.

- 14 KEYSTONE (Trapezoidal distortion correction) /TILT key**
Press this to adjust the trapezoidal distortion.
For details, see “Correcting the Trapezoidal Distortion Automatically (Auto V Keystone Correction)” on page 31.

Tilt function is not provided in this projector.

- 15 PIC MUTING key**

- 16 AUDIO MUTING key**

- 17 FREEZE key**
For pausing the projected image.

For details, see “To Freeze the Image Projected (Freeze)” on page 37.

Before using the Remote Commander

Pull out the clear film from the lithium battery holder.

To replace a battery

- 1 Pull out the battery cover by a thin stick inserting to a hole, as shown the illustration.

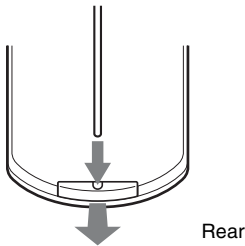

- 2 Install the lithium battery.

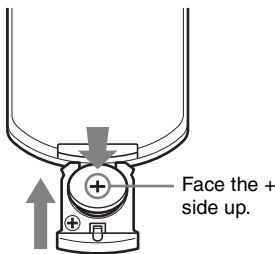

- 3 Put the lithium battery holder back into the Remote Commander.

Notes on the lithium battery

- A button type lithium battery (CR2025) is used in the Remote Commander. Do not use batteries other than CR2025.
- Keep the lithium battery out of the reach of children.
- Should the battery be swallowed, immediately consult a doctor.

Notes on Remote Commander operation

- Make sure that nothing obstructs the infrared beam between the Remote Commander and the remote control detector on the projector. Direct the Remote Commander toward the remote control detector.
- The operation range is limited. The shorter the distance between the Remote Commander and the remote control detector is, the wider the angle within which the commander can control the projector becomes.

CAUTION

Danger of explosion if battery is incorrectly replaced.

Replace only with the same or equivalent type recommended by the manufacturer.

When you dispose of the battery, you must obey the law in the relative area or country.



Installing the Projector

This unit can be operated on a floor or desktop (floor installation), but also can be suspended from a ceiling with a dedicated mounting device (ceiling installation). For details, see “Installing the Projector and Installation Diagram” on page 70.

Connecting the Projector

When you connect the projector, make sure to:

- Turn off all equipment before making any connections.
- Use the proper cables for each connection.
- Insert the cable plugs firmly; loose connections may reduce performance of picture signals. When pulling out a cable, be sure to pull it out by the plug, not the cable itself.

For VPL-DX15, when connecting to a  (Network) connector or  (USB) connector, see “Operating Instructions for Network/USB File Viewer” stored on the CD-ROM.

Connecting a Computer

This section describes how to connect the projector to a computer.

For more information, refer to the computer's instruction manual.

To connect a computer

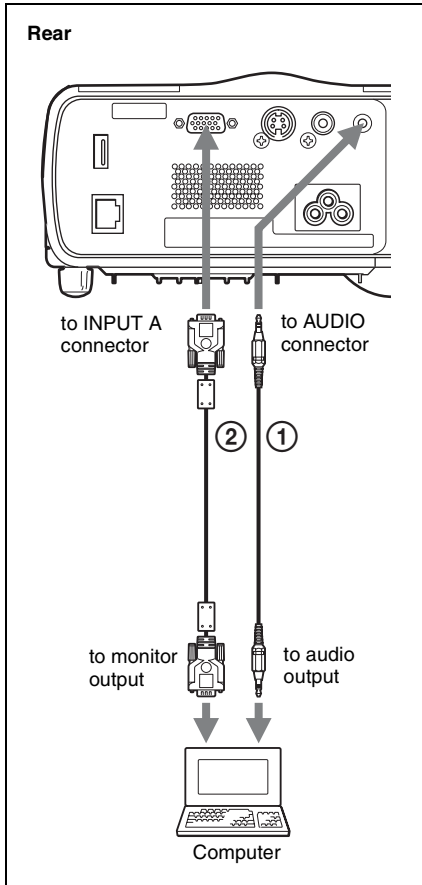

- ① Stereo audio connecting cable (not supplied)
(Use a no-resistance cable.)
- ② HD D-sub 15-pin cable (supplied)

Notes

- The projector accepts VGA, SVGA, XGA, WXGA, WXGA+, SXGA and SXGA+ signals. However, we recommend that you set the output mode of your computer to XGA for the external monitor.

- If you set your computer, such as a notebook computer, to output the signal to both your computer's display and the external monitor, the picture of the external monitor may not appear properly. Set your computer to output the signal to only the external monitor.

For details, refer to the operating instructions supplied with your computer.

Note

To connect a Macintosh computer equipped with a video output connector of a type having two rows of pins, use a commercially available plug adaptor.

Connecting a VCR

This section describes how to connect the projector to a VCR.

For more information, refer to the instruction manuals of the equipment you are connecting.

To connect to a video output connector

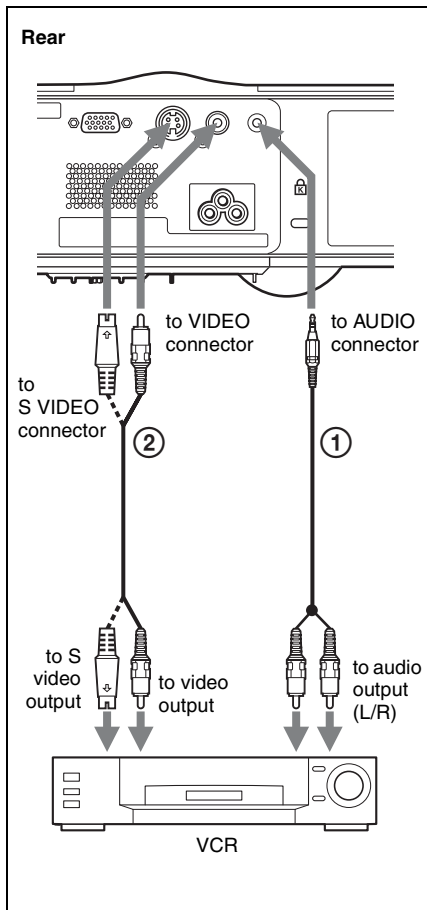

- ① Stereo audio connecting cable (not supplied)
(Use a no-resistance cable.)
- ② Video cable (not supplied) or S-Video cable
(not supplied)

To connect to a video GBR/ Component output connector

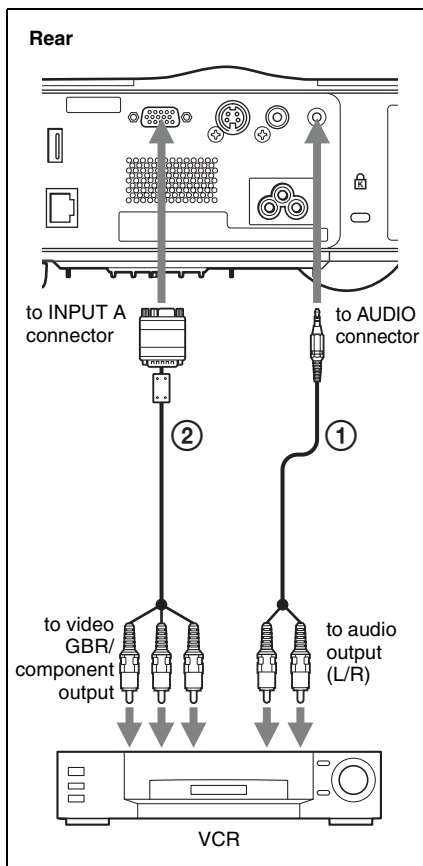

- ① Stereo audio connecting cable (not supplied)
(Use a no-resistance cable.)
- ② Signal Cable (not supplied)
HD D-sub 15-pin (male) ↔ 3 × phono plug

Notes

- Set the aspect ratio using “Aspect” on the Screen menu according to the input signal.
- When you connect the projector to a video GBR output connector, select “Video GBR” or when you connect the projector to a component output connector, select “Component” with the “Input-A Signal Sel.” setting on the Setup menu.

Connecting to a Network (VPL-DX15 only)

To see how to connect to a network, refer to “Operating Instructions for Network/USB File Viewer” included on the supplied CD-ROM.

Connecting a USB memory (VPL-DX15 only)

To see how to connect a USB memory, refer to “Operating Instructions for Network/USB File Viewer” included on the supplied CD-ROM.

Projecting

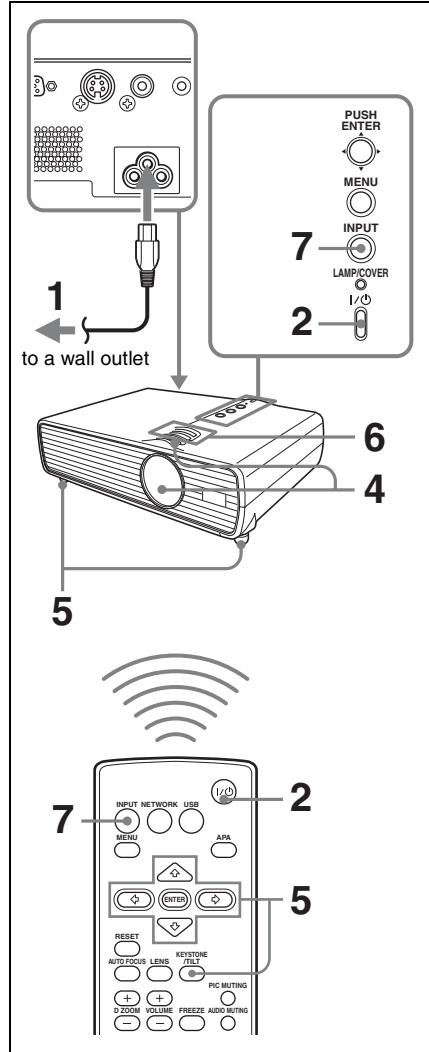

Projecting the Picture

- 1** Plug the AC power cord into a wall outlet, then connect all equipment. The I/O key lights in red and the projector goes into standby mode.
- 2** Press the I/O key to turn the power on.

- 3 Turn on the equipment connected to the projector.
- 4 Move the lens shutter lever to open the lens shutter.
- 5 Adjust the upper or lower position of the picture.
Use the adjuster to adjust the picture position.

Using the adjuster

- ① Lift the projector while pressing the Adjuster adjustment button.
- ② Adjust the tilt of the projector.
- ③ Release the Adjuster adjustment button.
- ④ When fine-tuning is necessary, turn the Adjuster right and left.

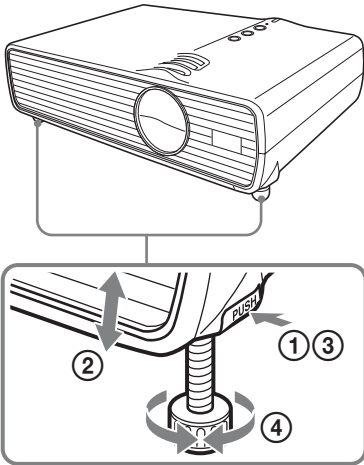

Notes

- When you adjust the tilt of the projector with the adjuster, the V keystone adjustment is performed at the same time. If you do not want to perform the automatic keystone adjustment, set the “V Keystone” to “Manual.” (See page 54.)
- If you set the “V Keystone” to “Auto,” the “V Keystone” correction is automatically adjusted. However, it may not be perfectly adjusted depending on the room temperature or the screen angle. In this case, adjust it manually.

Press the KEYSTONE key to display “V Keystone” on the screen, and adjust the value with the ▲/▼/◀/▶ keys. The adjusted value is valid until the power is turned off.

- Be careful not to let the projector down on your fingers.
- Do not push hard on the top of the projector with the adjuster extended. It may cause a malfunction.

- 6 Adjust the size of the picture and the focus.

Adjust the picture size using the Zoom ring and adjust the picture focus using the Focus ring.

- 7 Press the INPUT key to select the input source.

Each time you press the key, the input signal switches as follows:

Input signal indicator



VPL-DX10/DX11

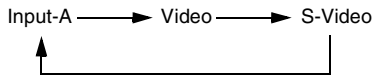

VPL-DX15

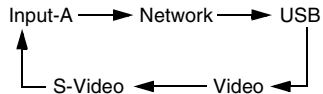

Input signal indicator

Shows the selected input channel. ×() is displayed when no signal is input. You can hide this indicator using “Status” on the Setup menu.

To input from	Press INPUT to display
Computer connected to the INPUT A connector	Input-A

To input from	Press INPUT to display
Video equipment connected to the VIDEO input connector	Video
Video equipment connected to the S VIDEO input connector	S-Video
Computer connected to a LAN to use the network function	Network
USB memory connected to the USB connector	USB

When the selected input is a computer signal, APA (Auto Pixel Alignment) functions automatically to adjust the image from the connected equipment for clear display.

For details, see “Adjusting the Image Quality (Smart APA)” on page 39.

When Network or USB is selected (VPL-DX15 only)

When Network is selected, the confirmation display to show disconnection with USB memory appears.

When USB is selected, the confirmation display to show disconnection with the network equipment appears.

If the network or USB memory is not connected, or if they are to be turned off, press the ENTER key.

Note

If “Auto Input Search” is set to “On,” the projector searches for the signals from the connected equipment and displays the input signal where the input signals are found. In VPL-DX15, if there is no input signal, “Network” is selected.

For details, see “Auto Input Search” on page 52.

8 Switch the equipment connected to output to the projector.

Depending on the type of your computer, for example a notebook, or an all-in-one LCD type, you may have to switch the computer to output to the

projector by pressing certain keys (e.g., LCD/VGA, , etc.), or by changing your computer’s settings.

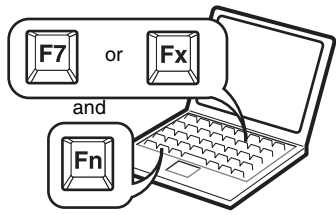

Note

The key used for switching the computer to output to the projector varies depending on the type of computer.

Turning Off the Power

- 1 Press the I/⏻ key.
“POWER OFF? Please press I/⏻ key again.” appears to confirm that you want to turn off the power.

Note

The message disappears if you press any key other than the I/⏻ key, or if you do not press any key for five seconds.

- 2 Press the I/⏻ key again.
The I/⏻ key flashes in green and the fan continues to run to reduce the internal heat.
- 3 Unplug the AC power cord from the wall outlet after the fan stops running and the I/⏻ key lights in red. (Except when using the Off & Go)
This product can be turned off without waiting for the fan to stop after your presentation has finished (Off & Go).

For details, see “Switching off Smoothly after Presentation (Off & Go)” on page 33.

When you cannot confirm the on-screen message

When you cannot confirm the on-screen message under certain conditions, you can turn off the power by holding the I/⏻ key for about two seconds instead of above steps 1 and 2.

To project again immediately

You can make the lamp light by turning on the power again even, while the I/⏻ key is flashing in green. There may be a delay, depending on conditions, before the lamp lights.

Selecting the Menu Language

You can select one of seventeen languages for displaying the menu and other on-screen displays. The factory setting is English.

To change the menu language, proceed as follows:

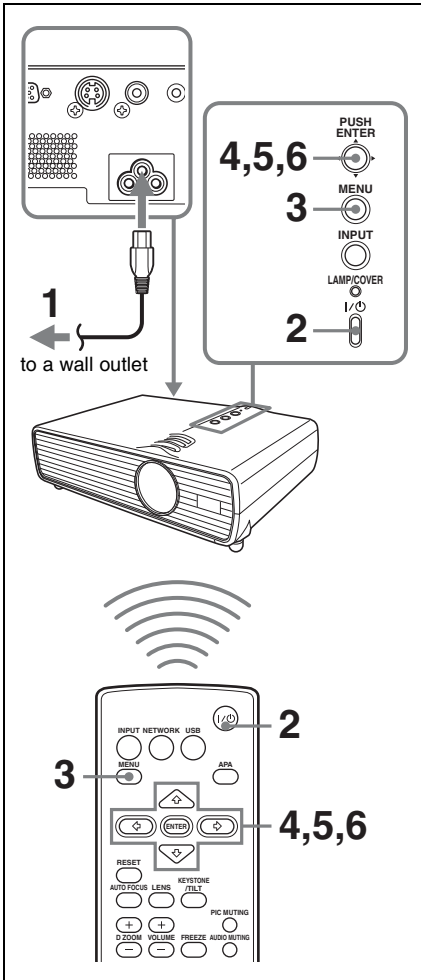

- 1** Plug the AC power cord into a wall outlet.
- 2** Press the I/O key to turn on the projector.
The I/O key flashes in green, and then lights in green.

- 3** Press the MENU key.
The menu appears.
The menu currently selected is shown as a yellow button.

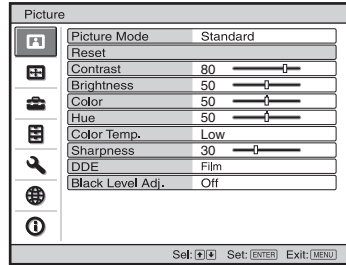

(VPL-DX15)

- 4** Press the ▲ or ▼ key to select the Setup menu, then press the ► or ENTER key.
The selected menu appears.

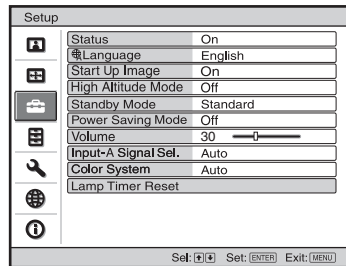

- 5 Press the ▲ or ▼ key to select “Language,” then press the ► or ENTER key.



- 6 Press the ▲/▼/◀/▶ key to select a language, then press the ENTER key. The menu changes to the selected language.

To clear the menu

Press the MENU key.
The menu also disappears automatically if a key is not pressed for one minute.

Resetting All Setting Values

You can reset all setting values to default.

To Change from the Menu

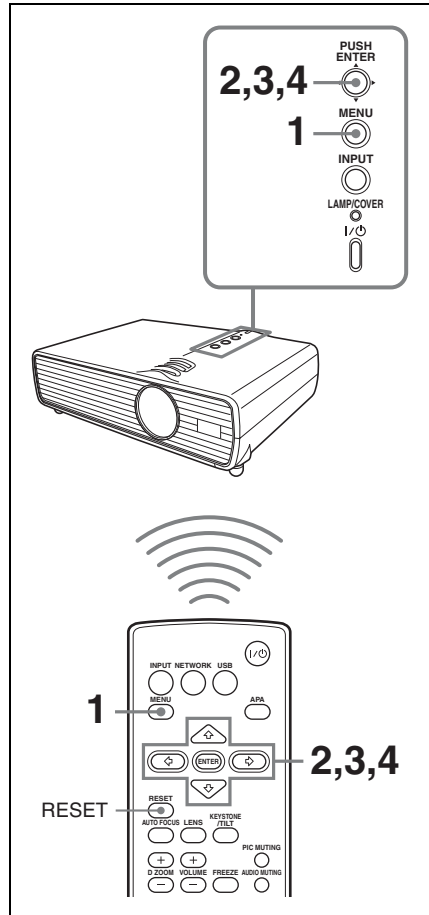

- 1 Press the MENU key. The menu appears.

- Press the ▲/▼ key to select the Picture menu then press the ► or ENTER key.

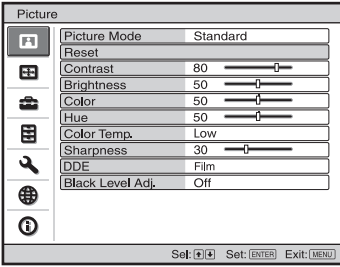

- Select “Reset” with the ▲/▼ key from the Picture menu then press the ENTER key.

For details, see to page 45.

- After the next window has appeared, select “Yes”, using the ◀/▶ key, then press the ENTER key.

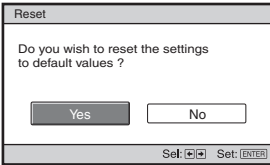

Factory-preset items:
 “Contrast,” “Brightness,” “Color,”
 “Hue,” “Color Temp.,” “Sharpness,”
 “DDE,” “Black Level Adj.,” and
 “Gamma Mode” (can be set on Picture menu).

To Return the Value of an Adjusted Item to Default

Press the RESET key on the Remote Commander.

If you press the RESET key while the item is being adjusted (the item is displayed in the window), it returns to the factory preset value.

Correcting the Trapezoidal Distortion Automatically (Auto V Keystone Correction)

This function automatically corrects trapezoidal distortion due to the projection angle.

Further Adjusting an Image That Has Been Automatically Adjusted

Note

If you wish to switch to auto adjustment mode after adjusting manually, switch the V Keystone setting to “Manual” once then return it to “Auto”.

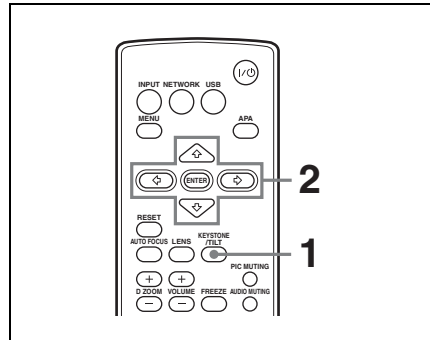

- Press the KEystone/TILT key. Correction menu appears.

- Adjust ▲/▼/◀/▶ with the ▲/▼/◀/▶ keys.

When the lower side is longer than the upper side (▤)

Adjust the volume so as to decrease it.

When the upper side is longer than the lower side (▥)

Adjust the volume so as to increase it.

The menu automatically goes off in approximately 5 seconds after operation.

To Change from the Menu

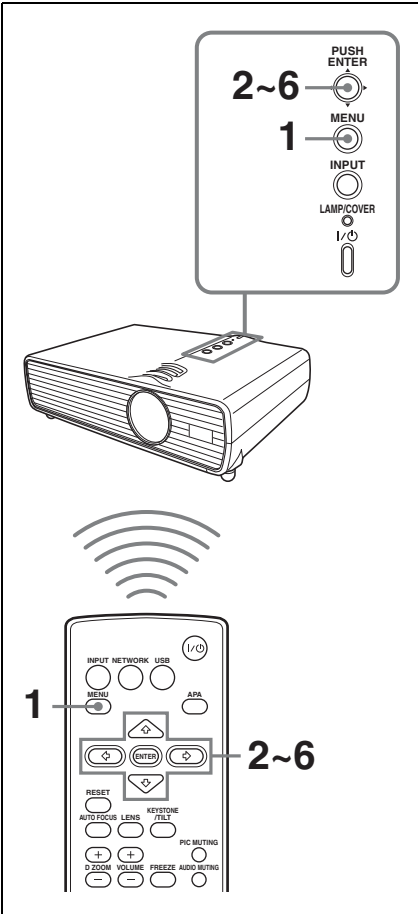

- 1 Press the MENU key.
The menu appears.

- 2 Press the ▲/▼ key to select the Installation setting menu then press the ► or ENTER key.

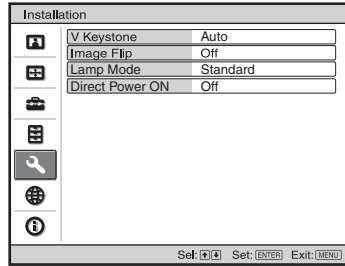

- 3 Select “V Keystone” with the ▲/▼ key from the Installation setting menu then press the ENTER key.

- 4 Select “Auto” for automatic correction or “Manual” to correct it manually. Then, press the ENTER key.

- 5 If you selected “Manual”, use the ▲/▼/◀/▶ keys.
When the lower side is longer than the upper side (▭)
 Adjust the volume to decrease it.
When the upper side is longer than the lower side (▭)
 Adjust the volume to increase it.

- 6 Press the ENTER key.

Notes

- The auto V Keystone adjustment may not correct the trapezoidal distortion perfectly, depending on the room temperature or the screen angle.
- Since the V keystone adjustment is an electronic correction, sometimes the image will be deteriorated.

Switching off Smoothly after Presentation (Off & Go)

You can disconnect the power cord immediately after turning off the unit. So you can move it readily if necessary.

Notes

- Turn off the projector according to the procedure explained in “Turning Off the Power” on page 28, then cool it down before storing the projector in the carrying case.
- When the power is turned on soon after it has been turned off, it may take some time until the lamp will light on.

Using the Security Function

Security Lock (Password)

The projector is equipped with a security lock function. When you turn the power of the projector on, you are required to input the previously set password. If you do not input the correct password, you will not be able to project the picture.

Notes

- When the security lock becomes effective, you are required to input the password only when you turn the projector on after disconnecting or reconnecting the cable.
- You will not be able to use the projector if you forget your password and the password administrator is not available. Be please aware that using the security lock can prevent valid usage in such cases.

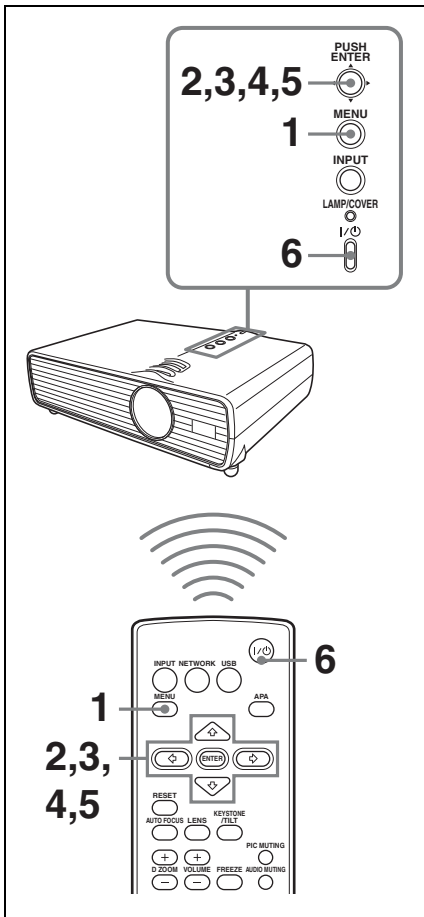

To use the security lock

- 1 Press the MENU key.
The menu appears.
- 2 Press the ▲/▼ key to select the Function menu then press the ► or ENTER key.

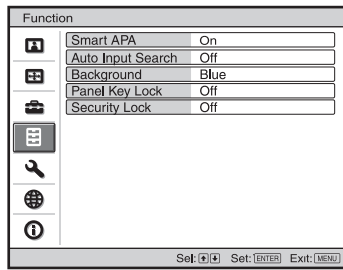

- 3 Select “On” of “Security Lock” with the ▲/▼ key from the Function menu then press the ENTER key.
- 4 Enter the password.
Use the MENU, ▲/▼/◀/▶, and ENTER keys to enter the four-digit password. (The default initial password setting is “ENTER, ENTER, ENTER, ENTER.” After this is entered you can put in your own password. Therefore, when you use this function for the first time, please input “ENTER” four times.)

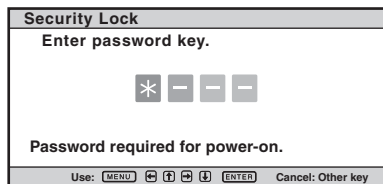

Next, the screen for entering the new password is displayed. (Enter the password on this screen even if you want to keep the current password.) Enter the password on this screen.



- 5 Enter the password again to confirm.



When “Security Lock enabled!” is displayed on the menu screen, the setting for security lock is completed.

If “Invalid Password!” is displayed on the menu screen, perform this procedure again from step 1.

- 6 Turn the main power off and disconnect the AC power cord.

The security lock is set to on, then it becomes effective. The screen used for entering the password is displayed when the power is turned on the next time.

Security certification

When the password screen is displayed, enter the password that was set. If you fail to enter the correct password after three tries, the projector cannot be used. In this case, press the I/⏻ key to turn off the power.

To cancel the security lock

- 1 Press the MENU key, then set the “Security Lock” setting to “off” in the Function menu.
- 2 Enter the password.
Enter the password that was set.

Note

If you call Sony personnel because you have forgotten the password, you will be asked to verify the projector’s serial number and your identity. (This process may differ in other countries/regions.) Once your identity has been confirmed, we will provide you with the password.

Panel Key Lock

The Panel Key Lock function enables locking of all keys on the control panel on the topside, which in the case only the Remote Commander can be used.

- 1 Press the MENU key.
The menu appears.
- 2 Press the ▲/▼ key to select the Function menu then press the ► or ENTER key.

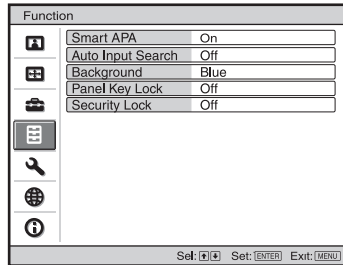

- 3 Select “Panel Key Lock” with the ▲/▼ key from the Function menu then press the ENTER key.

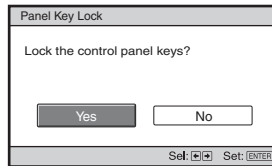

- 4 Select “Yes” with the ◀ key.
Panel Key Lock comes to be valid.

If it is set to “Yes”, the power can be turned on if you hold the I/⏻ key on the control panel pressed for approximately 10 seconds during Standby mode. While the projector enters into Standby mode if the I/⏻ key is held pressed for approximately 10 seconds during power on.

To cancel Panel Key Lock with the key on the projector

Press and hold the MENU key for approximately 10 seconds while the power is on. Locking is canceled, and the function is set to “Off”.

Security Lock (Mechanical)

A commercially available antitheft cable such as one (manufactured by Kensington) can be attached to the antitheft lock.

For details, refer to the home page of Kensington.

Kensington Web page address:
<http://www.kensington.com/>

Using Various Functions During Projecting

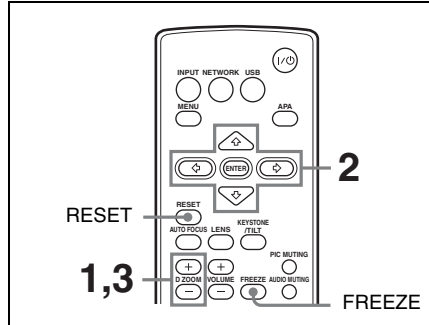

Zoom a Part of the Image (Digital Zoom)

You can select a section of the image to enlarge. This function will be active only when a signal from a computer is input or an input signal of “Network” or “USB” is selected. (VPL-DX15 only)

This function does not work when a video signal is input.

- 1 Project a normal image, and press the D ZOOM + key on the Remote Commander.

The digital zoom icon appears in the center of the image.

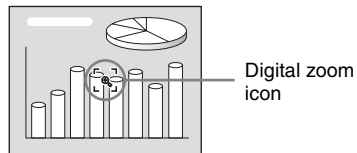

- 2 Move the icon to the point on the image you want to enlarge. Use the arrow key (▲/▼/◀/▶) to move the icon.

- 3 Press the D ZOOM + key again. The portion of the image where the icon is located is enlarged. The enlargement

ratio is displayed on the screen for a few seconds.

By pressing the + key repeatedly, the image size (ratio of enlargement: max. 4 times) increases.

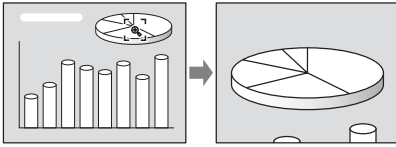

Use the arrow key (▲/▼/◀/▶) to scroll the enlarged image.

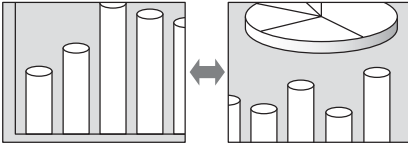

To return the image to its original size

Press the D ZOOM – key.

Just pressing the RESET key returns the image back to its original size immediately.

To Freeze the Image Projected (Freeze)

Press the FREEZE key. “Freeze” appears when the key is pressed. This function will be active only when a signal from a computer is input or an input signal of “Network” or “USB” is selected. (VPL-DX15 only)

To restore the original screen, press the FREEZE key again.

Pausing the Image

There are two ways to pause the image. The Lens shutter blocks the image by closing the shutter outside the lens. The picture muting shuts off the video signal.

Lens Shutter (Recommended for Use on the Floor)

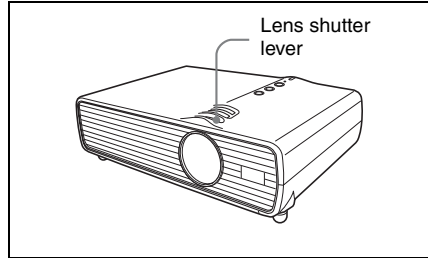

Projection is interrupted by closing the lens shutter with the lens shutter lever on the top of the unit.

While the lens shutter is closed, an all-black signal is output inside the projector.

The projector goes to standby mode approximately two hours after you close the lens shutter.

Picture Muting (Recommended for Use Suspend from a Ceiling)

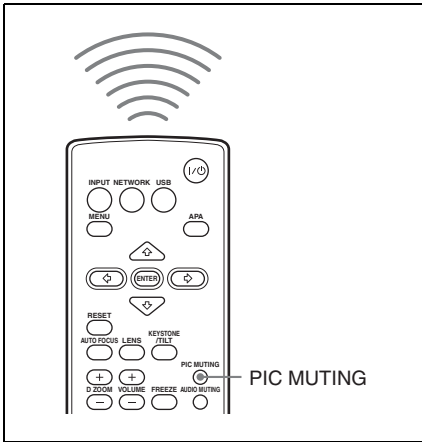

The projected image is muted by pressing the PIC MUTING key on the Remote Commander.

Pausing the Sound (Audio Muting)

The sound output from the speakers is muted temporarily by pressing the AUDIO MUTING key on the Remote Commander. To cancel it, press the AUDIO MUTING key again or press the VOLUME + key to increase the volume.

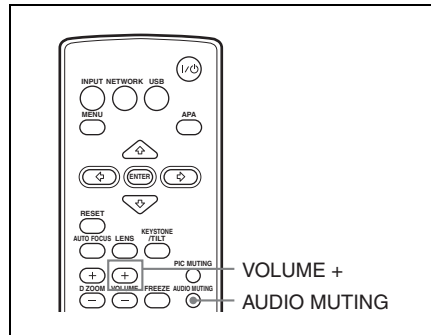

Adjusting the Image Quality (Smart APA)

APA (Auto Pixel Alignment) automatically adjusts the picture to be clear when a computer signal is input. “Phase”, “Pitch”, and “Shift” on the Screen menu are automatically adjusted. When “Smart APA” is set to “On”, this function works whenever a signal is input.

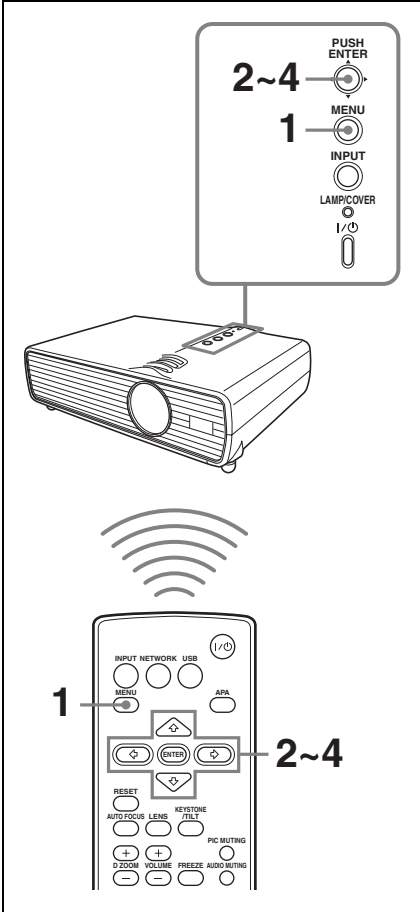

1 Press the MENU key.
The menu appears.

2 Press the ▲/▼ key to select the Function menu then press the ► or ENTER key.

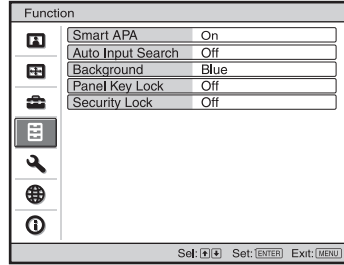

3 Select “Smart APA” with the ▲/▼ key from the Function menu then press the ► or ENTER key.

4 Select “On” or “Off” with the ▲/▼ key.

On: The APA function automatically starts when a computer signal is input so that the image will be clear. While it is “On”, the APA key on the Remote Commander can also be used to the image.

Off: Adjustment starts only when the APA key on the Remote Commander is pressed.

Notes

- Smart APA is applied only when a computer signal is input.
- Press the APA key when the full image is displayed on the screen. If the projected image includes a black portion around it, the APA will not work properly and some parts of the image may not be displayed on the screen.
- You can cancel the adjustment by pressing the APA key again while “Adjusting” appears on the screen.
- The picture may not be adjusted properly depending on the type of input signal.
- Adjust the “Phase,” “Pitch,” and “Shift” items in the Screen menu when you adjust the picture manually.

Setting the Picture Mode

The Picture Mode can be set to suit to the projected image. The setting value is registered for each mode.

Note

Adjustable or selectable items are limited in accordance with the types of the input signal on some menus.

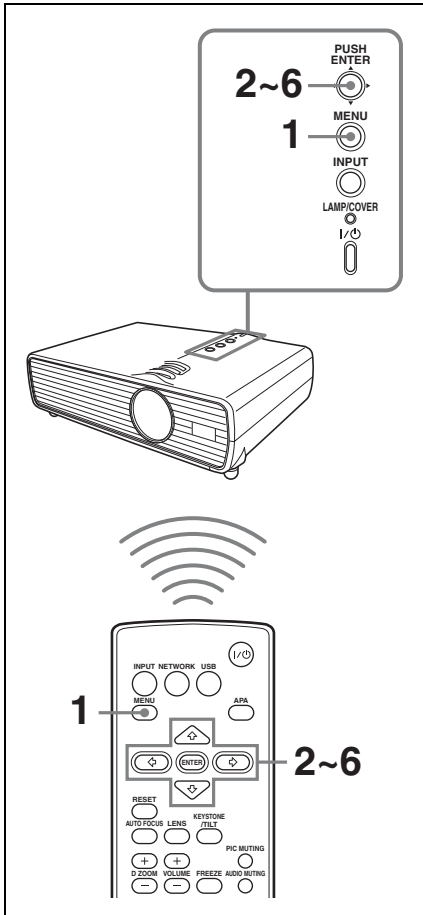

- 1 Press the MENU key.
The menu window appears.

- 2 Press the ▲/▼ key to select the Picture menu then press the ► or ENTER key.

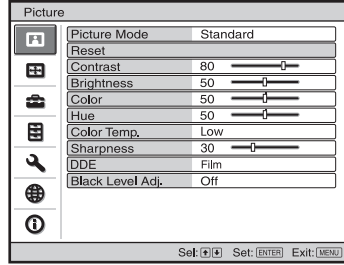

- 3 Select “Picture Mode” with the ▲/▼ key from the Picture menu then press the ► key or ENTER key.

- 4 Select “Picture Mode” with the ▲/▼ key to suit to the projected image then press the ENTER key.

Dynamic: Emphasizes the contrast to produce a “dynamic” picture.

Standard: Makes the picture natural and well balanced.

Presentation: Makes the picture bright to be suitable for a presentation when the signal is input from a computer or an input signal of Network* or USB* is selected (applied only when a computer signal is input or an input signal of Network* or USB* is selected).

* VPL-DX15 only

- 5 Set the items on the Picture menu as desired.

The setting values for each mode are registered individually.

- 6 Press the ENTER key.
The selected mode and its setting values are registered.

Starting the Network Function or the USB File Viewer With One Keypress (VPL-DX15 only)

The network function or the USB file viewer can be easily started by pressing the NETWORK or USB key on the Remote Commander.

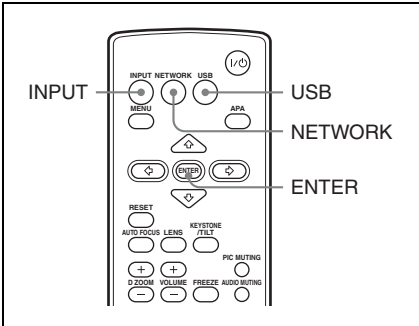

By pressing the NETWORK key on the Remote Commander

The network function starts.

By pressing the USB key on the Remote Commander

The USB file viewer starts.

Using the Network Function (VPL-DX15 only)

You can use the following functions by using the network function of this product.

For details, refer to “Operating Instructions for Network/USB File Viewer” included on the supplied CD-ROM.

Projecting the File in the USB Memory Directly (VPL-DX15 only)

The file in the USB memory connected to the  (USB) port can be displayed directly on the projected display.

For details, refer to “Operating Instructions for Network/USB File Viewer” included on the supplied CD-ROM.

Using a MENU

The projector is equipped with an on-screen menu for making various adjustments and settings. Some of the adjustable/setting items are displayed in a pop-up menu, in a setting menu or adjustment menu with no main menu, or in the next menu window. If you select an item name followed by an arrow (►), the next menu window with the setting items appears.

To change the on-screen menu language, see “Selecting the Menu Language” on page 29.

This manual contains explanations for the VPL-DX10/DX11 and VPL-DX15 all together. Be aware that the VPL-DX15 is mainly used for explanation of the display, and there may be an item that is not displayed due to the model.

- 1 Press the MENU key.
The menu appears.

VPL-DX15

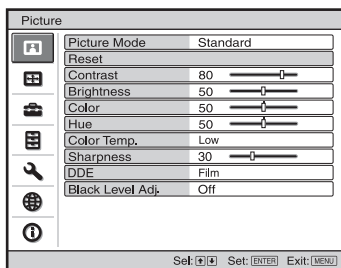

VPL-DX10/DX11

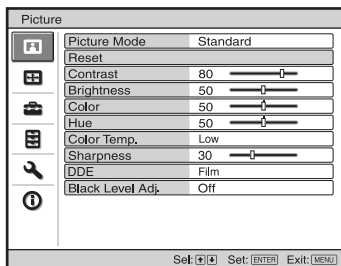

- 2 Use the ▲ or ▼ key to select a menu, then press the ► or ENTER key.
The items that can be set or adjusted with the selected menu appear. The item presently selected is shown in yellow.

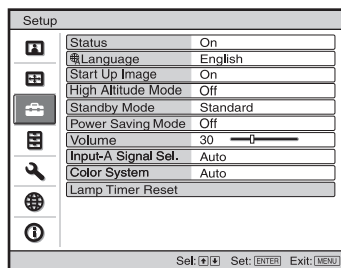

- 3 Use the ▲ or ▼ key to select the item, then press the ► or ENTER key.
The setting items are displayed in a pop-up menu, in a setting menu, in an adjustment menu or in the next menu window.

Pop-up menu

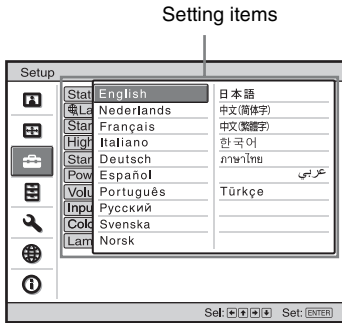

Setting menu

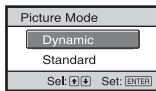

Adjustment menu

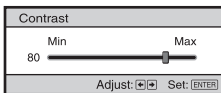

Next menu window

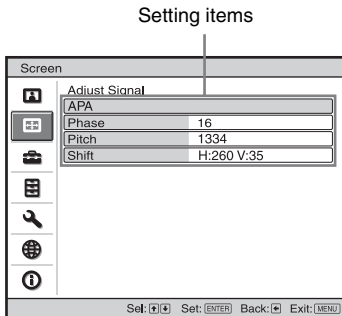

4 Make the setting or adjustment of an item.

• When changing the adjustment

level:

To increase the number, press the ▲ or ► key.

To decrease the number, press the ▼ or ◀ key.

Press the ENTER key to restore the previous screen.

• When changing the setting:

Press the ▲ or ▼ key to change the setting.

Press the ENTER key to restore the previous screen.

You can restore the previous screen using ◀ depending on the selected item.

To clear the menu

Press the MENU key.

The menu disappears automatically if a key is not pressed for one minute.

Unadjustable items

The adjustable items are limited depending on the input signals. The items that cannot be adjusted or set do not appear in the menu.

For details, see page 56.

Storage of the settings

The settings are automatically stored in the projector memory.

If no signal is input

If there is no input signal, “Cannot adjust this item.” appears on the screen.

The Picture Menu

The Picture menu is used for adjusting the picture. Items that can be adjusted or set depend on the kind of input signals.

For details, see “Input signals and adjustable/setting items” on page 56.

When the video signal is input

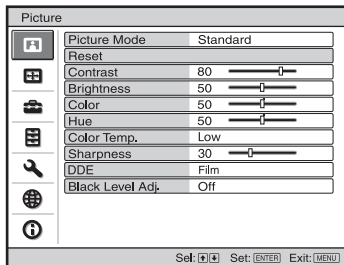

When the signal is input from a computer

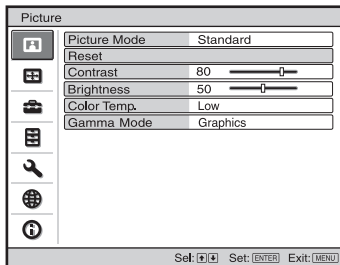

Setting items	Functions	Initial setting
Picture Mode	<p>Selects the picture mode.</p> <p>A setting value is stored for each setting item.</p> <ul style="list-style-type: none"> • Dynamic: Emphasizes the contrast to produce a “dynamic” picture. • Standard: Makes the picture be natural and well balanced. • Presentation: Makes the picture bright to be suitable for a presentation when the signal is input from a computer or an input signal of Network* or USB* is selected. <p>* VPL-DX15 only</p>	Set according to the input signal
Reset	<p>The following settings are initialized to their factory preset values: “Contrast”, “Brightness”, “Color”, “Hue”, “Color Temp.”, “Sharpness”, “DDE”, “Black Level Adj.”, and “Gamma Mode” in the Picture menu.</p> <p>For details, see “Resetting All Setting Values” on page 30.</p>	–
Contrast	<p>Adjusts the contrast of pictures.</p> <p>The higher the setting, the greater the contrast. The lower the setting, the lower the contrast.</p>	80
Brightness	<p>Adjusts the brightness of the picture.</p> <p>The higher the setting, the brighter the picture. The lower the setting, the darker the picture.</p>	50
Color	<p>Adjusts the intensity of the color density.</p> <p>The higher the setting, the greater the intensity. The lower the setting, the lower the intensity.</p>	50
Hue	<p>Adjusts the color tone.</p> <p>The higher the setting, the more greenish the picture becomes. The lower the setting, the more reddish the picture becomes.</p>	50

Setting items	Functions	Initial setting
Color Temp.	Adjusts the color temperature. <ul style="list-style-type: none"> • High: Gives white colors a blue tint. • Low: Gives white colors a red tint. 	Low
Sharpness	Adjusts the sharpness of the image. The higher the setting, the sharper the picture. The lower the setting, the softer the picture, thus reducing the noise.	30
DDE (Dynamic Detail Enhancer)	According to the film source you have selected, make a setting for playback. <ul style="list-style-type: none"> • Film: Normally, select this option. Reproduces the 2-3 Pull-Down film sources with smooth picture movement. When the video signal with a format other than the 2-3 Pull-Down is input, “Progressive” is automatically selected. • Progressive: Converts an interlace format video signal to a progressive format. • Off: Plays a video signal in an interlace format without converting. 	Film
Black Level Adj. (Adjust)	Dark parts will be clear. Set according to the input signal source. <ul style="list-style-type: none"> • High: Gives higher emphasis to the black color. • Low: Gives lower emphasis to the black color. • Off: Cancels this feature. 	Off
Gamma Mode	Selects a gamma correction curve. <ul style="list-style-type: none"> • Graphics: Improves the reproduction of halftones. Photos can be reproduced in natural tones. • Text: Contrasts black and white. Suitable for images that contain lots of text. 	Graphics

Notes

- When the “Picture Mode” is set to “Presentation”, the setting item of “Color Temp.” is not displayed.
- For Picture Mode, a part of the setting items cannot be displayed on the screen according to the input signal.
- The Picture Mode setting is common between Network and USB. (VPL-DX15 only)

The Screen Menu

The Screen menu is used to adjust the input signal. You can also adjust the aspect ratio of the picture.

Items that can be adjusted or set depend on the kind of input signals.

For details, see “Input signals and adjustable/setting items” on page 56.

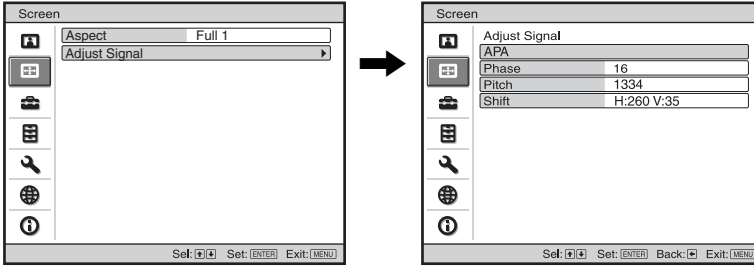

Setting items	Functions	Initial setting
Aspect (When the video signal is input)	<p>Sets the aspect ratio of the picture to be displayed for the current input signal. This item is enabled only when an video signal (preset memory numbers 1 to 11) is input.</p> <ul style="list-style-type: none"> • Zoom: Select this when black bands are displayed in both sides by the squeeze signal. • 4:3: Select to view a picture with normal 4:3 aspect ratio. • 16:9: Select to view a picture squeezed. 	Set according to the input signal
Aspect (When the computer signal is input)	<p>Sets the aspect ratio of the picture to be displayed for the current input signal. This item is enabled only when an PC signal (preset memory numbers 21 to 63) is input.</p> <ul style="list-style-type: none"> • Full1: Displays a picture vertically or horizontally to fill the screen without changing the aspect ratio of the original picture. • Normal: Displays the picture while matching one pixel of input picture element to that of the LCD. The picture will be clear but the picture size will be smaller. • 4:3: Makes the aspect ratio 4:3. • 16:9: Makes the aspect ratio 16:9. 	Set according to the input signal

Setting items	Functions	Initial setting
Adjust Signal		Set according to the input signal
APA (Auto Pixel Alignment)	Executes the APA when you press the ENTER key. The APA function adjusts PHASE, PITCH, and SHIFT automatically to suit to the input signal. The APA function can be used only for a computer signal. <i>For details, see “Adjusting the Image Quality (Smart APA)” on page 39.</i>	
Phase	Adjusts the dot phase of the panel and the computer signal, when the computer signal is input. Adjusts the picture to the point where it looks clearest.	
Pitch	Adjusts the horizontal size of the picture from a computer. The higher the setting, the wider the picture. The lower the setting, the narrower the picture. Adjust the setting to match the number of dots of the input signal.	
Shift	Adjusts the position of the picture. <ul style="list-style-type: none"> • H: As the setting for H (horizontal) increases, the picture moves to the right, and as the setting decreases, the picture moves to the left. Use ◀/▶ key to adjust the horizontal position. • V: As the setting for V (vertical) increases, the picture moves up, and as the setting decreases, the picture moves down. Use ▲/▼ key to adjust the vertical position. 	

Note

For Aspect, “Aspect” itself or a part of the setting items cannot be displayed on the screen according to the input signal.

About the Preset Memory No.

This projector has 46 types (VPL-DX15)/45 types (VPL-DX10/DX11) of preset data for input signals (the preset memory). When a preset signal is input, the projector automatically detects the signal type and recalls the data for the signal from the preset memory to adjust it to an optimum picture.

The memory number and signal type of that signal are displayed on the Information menu (page 56). You can also adjust the preset data through the Screen menu.

This projector has 20 types of user memories for Input-A into which you can save the setting of the adjusted data for an unpreset input signal.

When an unpreset signal is input for the first time, a memory number is displayed as 0. When you adjust the data of the signal using the Screen menu, it will be registered in the projector. If more than 20 user memory items are registered, the newest memory always overwrites the oldest one.

See the chart on page 68 to find if the signal is registered in the preset memory.

Notes

- When “Aspect” of the Screen menu is set to other than “Zoom”, a part of the screen may be displayed in black.
- Note that if the projector is used for profit or for public viewing, modifying the original picture by switching to the aspect mode may constitute an infringement of the rights of authors or producers, which are legally protected.

The Setup Menu

The Setup menu is used for changing the settings of the projector.

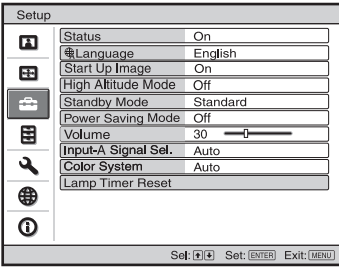

Setting items	Functions	Initial setting
Status	<ul style="list-style-type: none"> • On: Displays on-screen information (menu, etc.) on the projection screen. • Off: Turns off the on-screen displays except for the menus, message when turning off the power, and warning messages. 	On
Language	Selects the language used in the menu and on-screen displays. Available languages are: English, Dutch, French, Italian, German, Spanish, Portuguese, Russian, Swedish, Norwegian, Japanese, Chinese (Simplified Chinese), Chinese (Traditional Chinese), Korean, Thai, Arabic and Turkish.	English
Start Up Image	<ul style="list-style-type: none"> • On: Displays the Start Up Image on the screen after turning on the power. • Off: Does not displays the Start Up Image on the screen after turning on the power. 	On
High Altitude Mode	<p>Uses this item when using the projector at high altitudes.</p> <ul style="list-style-type: none"> • On: Use this setting when using the projector at an altitude of 1,500 m or higher. • Off: Use this setting when using the projector at normal altitudes. 	Off
Standby Mode	<ul style="list-style-type: none"> • Standard: Lowers the power consumption in standby mode. • Low: The power consumption in standby is more lowered. 	Standard
Power Saving Mode	<p>Selects the power saving mode.</p> <ul style="list-style-type: none"> • Lamp Cutoff: The lamp goes off and the I/⏻ key lights in orange if no signal is input for 10 minutes. The lamp lights again when a signal is input or any key is pressed. • Standby: The projector goes into standby mode and the I/⏻ key lights in red if no signal is input for 10 minutes. To use it, turn on the power again. • Off: The projector does not go into power saving mode. 	Off



Setting items	Functions	Initial setting
Volume	Adjusts the volume.	30
Input-A Signal Sel.	Selects the type of signal input from the equipment connected to the INPUT A connector. Selects the type of signal input from the equipment by selecting "Input-A" with the INPUT key. <ul style="list-style-type: none">• Auto: Selects the input signal type automatically.• Computer: Inputs the signal from a computer.• Video GBR: Inputs the signal from a TV game or HDTV broadcast.• Component: Inputs the component signal from a DVD player/recorder, Blu-ray Disc player, digital tuner, etc.	Auto
Color System	Selects the color system of the input signal. <ul style="list-style-type: none">• Auto: Selects the color system of the input signal automatically from among NTSC_{3.58}, PAL, SECAM, NTSC_{4.43}, PAL-M, PAL-N, or PAL60.• "NTSC_{3.58}"-"PAL-N": Allows you to set the color system to the selected system manually.	Auto
Lamp Timer Reset	When replacing the lamps, reset the lamp timer.	—

Notes

- If you turn on "High Altitude Mode" to "On" at an altitude less than 1,500 m (4,921 feet), the projector may reduce the reliability of the lamp.
- When "High Altitude Mode" is set to "On", the number of turns of the fan increases, and the fan noise becomes slightly louder.
- If "Standby Mode" is set to "Low," the network and network control function cannot be operated while the unit is in standby mode.
- When the input signal is not displayed correctly even if "Input-A Signal Sel." set to "Auto," select the item according to the input signal.
- Normally, set "Color System" to "Auto." If the picture is distorted or colorless, select the color system appropriate for the input signal.

The Function Menu

The Function menu is used for changing the settings of the various functions of the projector.

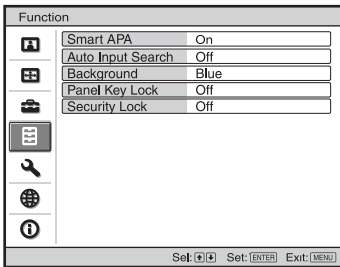

Setting items	Functions	Initial setting
Smart APA	<p>Executes APA automatically when a computer signal is input.</p> <p><i>For details, see “Adjusting the Image Quality (Smart APA)” on page 39.</i></p> <ul style="list-style-type: none"> • On: For Smart APA to be active • Off: For Smart APA to be inactive 	On
Auto Input Search	<p>Detects the input signal and displays the detected input signal automatically when the INPUT key is pressed.</p> <ul style="list-style-type: none"> • On: Checks if an input signal of Input-A, Network*, USB*, Video and S-Video in order when the INPUT key is pressed, and then displays the input terminal at which the input signal is detected. (* VPL-DX15 only) Network and USB are always displayed, as they have input signals (VPL-DX15 only). • Off: Sets when you want to select an input selector with no input signal, or you want to switch the setting manually. 	Off
Background	<p>Selects the background color of the screen when no signal is input.</p> <ul style="list-style-type: none"> • Black: The background color will be black. • Blue: The background color will be blue. 	Blue
Panel Key Lock	<p>Locks all the control panel keys of the projector so that the projector can be operated only with the Remote Commander.</p> <ul style="list-style-type: none"> • On: For Panel Key Lock to be active <p><i>For details, see “Using the Security Function” on page 33.</i></p> <p>To release the lock with the projector, press and hold the MENU key for about 10 seconds when the power is on. The lock will be released and “Panel Key Lock” is automatically set to “Off.”</p> <ul style="list-style-type: none"> • Off: For Panel Key Lock to be inactive 	Off



Setting items	Functions	Initial setting
Security Lock	Sets whether to require the user to input a password when turning on the power. • On: For Security Lock to be active <i>For details, see “Using the Security Function” on page 33.</i> • Off: For Security Lock to be inactive	Off

Notes

- Press the APA key when the full image is displayed on the screen. If the projected image includes a black portion around it, the APA function will not work properly and some parts of the image may not be displayed on the screen.
- You can cancel the adjustment by pressing the APA key again while “Adjusting” appears on the screen.
- For APA, the picture may not be adjusted properly depending on the type of input signal.
- Adjust the “Phase,” “Pitch,” and “Shift” items in the Screen menu when you adjust the picture manually.

The Installation Menu

The Installation menu is used for changing the settings of the projector.

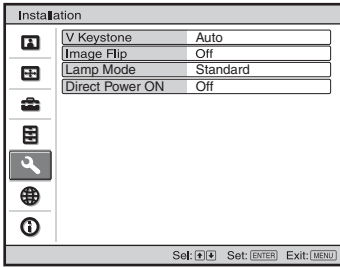

Setting items	Functions	Initial setting
V Keystone	Sets Auto V Keystone correction. <ul style="list-style-type: none"> • Auto: For Auto V Keystone correction to be active • Manual: For Auto V Keystone correction to be inactive <i>For details, see “Correcting the Trapezoidal Distortion Automatically (Auto V Keystone Correction)” on page 31.</i>	Auto
Image Flip	Flips the picture on the screen horizontally and/or vertically. Use this item for installation for rear projection. <ul style="list-style-type: none"> • HV: Flips the picture horizontally and vertically. • H: Flips the picture horizontally. • V: Flips the picture vertically. • Off: The picture does not flip. 	Off
Lamp Mode	Sets the lamp brightness used during the projection. <ul style="list-style-type: none"> • High: For the projected image to be brighter than Standard Select this when ambient lighting is too bright to view the display clearly. • Standard: For the projected image in standard brightness 	Standard
Direct Power On	Set to “On” if you are using a circuit breaker to turn the power on/off the entire system. You can turn the power on/off without pressing the I/O key.	Off

Notes

- Since the V keystone adjustment is an electronic correction, sometimes the image will be deteriorated.
- When the Lamp Mode is set to “High”, the sound from the fan to cool the lamp, etc. is often excessive.

The Network Setting Menu (VPL-DX15 only)

The Network Setting menu is used to set the network of this unit.

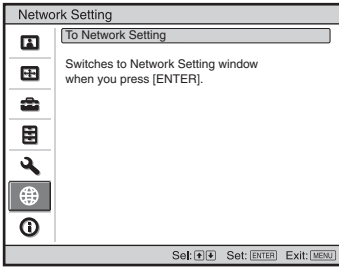

Setting items	Functions
Network Setting	The network setting window appears. For details, refer to “Operating Instructions For Network/USB File Viewer” included on the supplied CD-ROM.

The Information Menu

The Information menu displays the model name, serial number, the horizontal and vertical frequencies of the input signal and the cumulated hours of usage of the lamp.

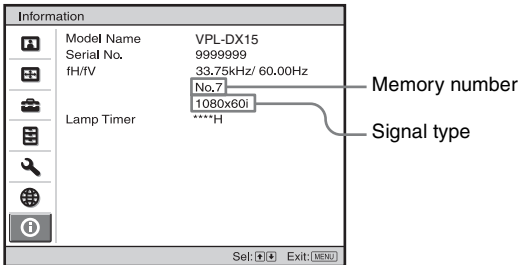

Setting items	Functions
Model Name	Displays the model name.
Serial No.	Displays the serial number.
fH (horizontal frequency)	Displays the horizontal frequency of the input signal.
fV (vertical frequency)	Displays the vertical frequency of the input signal.
Memory No.	Displays the preset memory number of the input signal.
Signal Type	Displays the type of the input signal.
Lamp Timer	Indicates the total usage time of a lamp.

Notes

- fH (horizontal frequency) and fV (vertical frequency) may not be displayed depending on the input signal used on the projector.
- You cannot change the displays listed above.

Input signals and adjustable/setting items

Some of the items in the menus cannot be adjusted depending on the input signal as indicated in the following tables. The items that cannot be adjusted are not displayed in the menu.

Picture menu

Item	Input signal					
	Video/S-Video	Component	Video GBR	Computer	Network ^{*5}	USB ^{*5}
Picture Mode	●	●	●	●	●	●
Contrast	●	●	●	●	●	●
Brightness	●	●	●	●	●	●
Color	● ^{*1}	●	●	—	—	—

Item	Input signal					
	Video/ S-Video	Component	Video GBR	Computer	Network ^{*5}	USB ^{*5}
Hue	● ^{*2}	●	●	—	—	—
Color Temp.	●	●	●	● ^{*3}	● ^{*3}	● ^{*3}
Sharpness	●	●	●	—	—	—
DDE	●	●	●	—	—	—
Black Level Adj.	●	●	●	—	—	—
Gamma Mode	—	—	● ^{*4}	●	●	●

● : Adjustable/can be set

— : Not adjustable/cannot be set

*1: Except B & W

*2: NTSC^{3.58} and NTSC^{4.43} only, except B & W

*3: Adjustable only when the “Picture Mode” is set to “Dynamic” or “Standard”

*4: Preset memory No. 3, 4 only

*5: VPL-DX15 only/The Picture Mode setting is common between Network and USB.

Screen menu

Item	Input signal					
	Video/ S-Video	Component	Video GBR	Computer	Network ^{*6}	USB ^{*6}
Aspect	●	●	●	●	—	—
Adjust Signal						
APA	—	—	—	●	—	—
Phase	—	—	—	●	—	—
Pitch	—	—	—	●	—	—
Shift	—	●	●	●	—	—

● : Adjustable/can be set

— : Not adjustable/cannot be set

*6: VPL-DX15 only

Replacing the Lamp

The lamp used as a light source is a consumable product. Thus, replace the lamp with a new one in the following cases.

- When the lamp has burnt out or dims
- “Please replace the Lamp.” appears on the screen
- The LAMP/COVER indicator flashes in orange (Repetition rate of 3 flashes) (Refer to page 64 for another possible cause.)

The lamp life varies depending on conditions of use.

Use an LMP-D200 Projector Lamp as the replacement lamp.

Use of any other lamps than the LMP-D200 may cause damage to the projector.

Caution

The lamp remains hot after the projector is turned off with the I/⏻ key. **If you touch the lamp, you may burn your finger. When you replace the lamp, wait for at least an hour for the lamp to cool.**

Notes

- **If the lamp breaks, contact qualified Sony personnel.**
- Pull out the lamp by holding the handle. If you touch the lamp, you may be burned or injured.
- When removing the lamp, make sure it remains horizontal, then pull straight up. Do not tilt the lamp. If you pull out the lamp while it is tilted and if the lamp breaks, the pieces may scatter, causing injury.

- 1 Turn off the projector, and disconnect the AC power cord from the AC outlet.

Note

When replacing the lamp after using the projector, wait for at least an hour for the lamp to cool.

- 2 Place a protective sheet (cloth) beneath the projector. Turn the projector over so you can see its underside.

Note

Be sure that the projector is stable after turning it over.

- 3 Open the lamp cover by loosening one screw with a Phillips screwdriver.

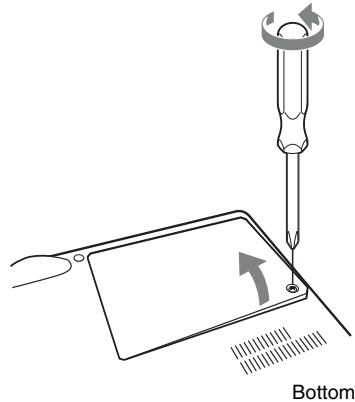

Note

For safety reasons, do not loosen any other screws.

- 4 Loosen the two screws on the lamp unit with the Phillips screwdriver (1). Fold out the handle (2), then pull out the lamp unit by the handle (3).

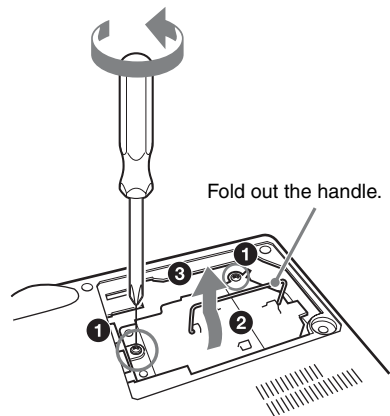

Caution

Do not put your hands into the lamp replacement slot, and do not allow any liquid or other objects into the slot **to avoid electrical shock or fire.**

- 5 Insert the new lamp all the way in until it is securely in place (1). Tighten the two screws (2). Fold down the handle to replace it (3).

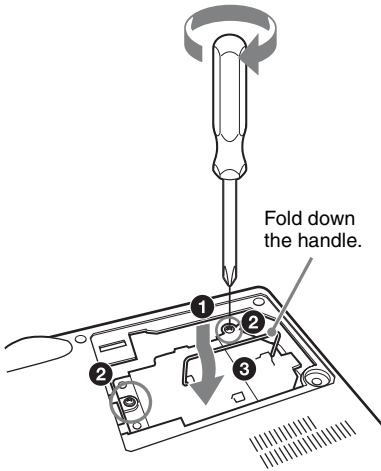

Notes

- Be careful not to touch the glass surface of the lamp and a inside conductor.
- Insert the handle firmly to attach it securely.
- The power will not turn on if the lamp is not secured properly.

- 6 Close the lamp cover and tighten one screw.

Note

Be sure to attach the lamp cover securely as it was. If not, the projector cannot be turned on.

- 7 Turn the projector back over.
- 8 Connect the power cord.
The I/⏻ key lights in red.

- 9 Press the I/⏻ key to turn the projector on.
- 10 Press the MENU key, and then select the Setup menu.
- 11 Select “Lamp Timer Reset”, and then press the ENTER key.

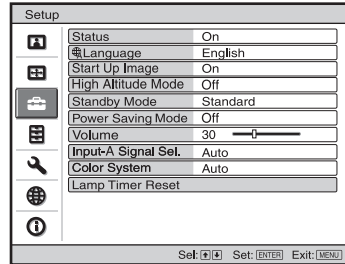

“Settings for Lamp replacement. Has the projection Lamp been replaced?” is displayed in the menu screen.

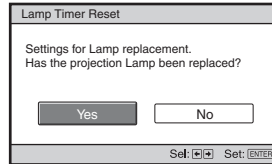

- 12 Select “Yes” with the ◀ key, and then press the ENTER key.
The Lamp Timer is initialized to 0, “Lamp Timer Reset Complete!” is displayed in the menu screen.

Disposal of the used lamp

For the customers in the USA

Lamp in this product contains mercury. Disposal of these materials may be regulated due to environmental considerations. For disposal or recycling information, please contact your local authorities or the Electronic Industries Alliance (www.eiae.org).

Cleaning the Air Filter

The air filter should be cleaned after approximately 500 hours use. Remove the air filter cover then remove the dust with a cloth lightly dampened with mild detergent solution.

The time needed to clean the air filter will vary depending on the environment or how the projector is used.

- 1** Turn the power off and unplug the power cord.
- 2** Place a protective sheet (cloth) beneath the projector and turn the projector over.
- 3** Remove the air filter cover.

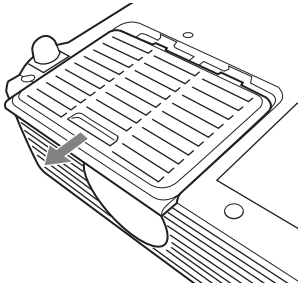

- 4** Remove the filter inside, and then wipe its dust with mild detergent.
- 5** Return the filter to the air filter cover.
- 6** Return the air filter cover.

Notes

- If the dust cannot be removed from the air filter, replace the air filter with a new one. For details on new air filter, consult with qualified Sony personnel.
- Be sure to attach the air filter cover firmly; it may cause a problem if the air filter cover is not installed properly.

Troubleshooting

If the projector appears to be operating erratically, try to diagnose and correct the problem using the following instructions. If the problem persists, consult with qualified Sony personnel.

Power

Symptom	Cause and Remedy
The power is not turned on.	<ul style="list-style-type: none"> • The AC power cable is not connected. → Connect the AC power cable firmly. • The lamp or lamp cover is not secured. → Close the lamp or lamp cover securely (page 59).

Picture

Symptom	Cause and Remedy
No picture.	<ul style="list-style-type: none"> • The power is not turned on. → Turn on the power (page 28). • A cable is disconnected or the connections are wrong. → Check that the proper connections have been made (page 22). • The Lens shutter is closed. → Open the Lens shutter (page 17, 37). • Input selection is incorrect. → Select the input source correctly (page 26). • The picture is muted. → Press the PIC MUTING key to release the picture muting (page 38). • The computer signal is not set to output to an external monitor or set to output both to an external monitor and a LCD monitor of a computer. → Set the computer signal to output only to an external monitor (page 23).
The picture is noisy.	<ul style="list-style-type: none"> • The connecting cable may not be connected properly. → Check if the connecting cable is connected properly.
On-screen display does not appear.	<ul style="list-style-type: none"> • “Status” in the Setup menu has been set to “Off.” → Set “Status” in the Setup menu to “On” (page 50).
Color balance is incorrect.	<ul style="list-style-type: none"> • The image quality setting is not proper. → Set the image quality on the Picture menu. → You can reset all values to default (page 30). • The setting of “Input-A Signal Sel.” in the Setup menu is incorrect. → Select “Computer,” “Video GBR” or “Component” correctly according to the input signal (page 51). • The projector is set to the wrong color system. → Set “Color System” in the Setup menu to match the color system being input (page 51).
The picture is too dark.	<ul style="list-style-type: none"> • Contrast or brightness has not been adjusted properly. → Adjust the Contrast or Brightness in the Picture menu properly (page 45). → You can reset all values to default (page 30). • The lamp has burnt out or is dim. → Check “Lamp Timer” on the Information menu (page 56).

Symptom	Cause and Remedy
The picture is not clear.	<ul style="list-style-type: none"> • The picture is out of focus. → Adjust the focus (page 26). • Condensation has accumulated on the lens. → Leave the projector for about two hours with the power on.
The image extends beyond the screen.	<ul style="list-style-type: none"> • The APA key has been pressed even though there are black edges around the image. → Display the full image on the screen and press the APA key. • The screen setting is not proper. → Adjust “Shift” on the Screen setting menu. → You can reset all values to default (page 30).
The picture flickers.	<ul style="list-style-type: none"> • The screen setting is not proper. → Adjust “Phase” on Screen setting menu. → You can reset all values to default (page 30).
The aspect ratio of the display is not right.	<ul style="list-style-type: none"> • The screen setting is not proper. → Adjust “Aspect” on the Screen setting menu. → You can reset all values to default (page 30).

Sound

Symptom	Cause and Remedy
No sound.	<ul style="list-style-type: none"> • A cable is disconnected or the connections are wrong. → Check that the proper connections have been made (page 22). • The audio connecting cable used is incorrect. → Use a no-resistance stereo audio cable (page 22). • The sound is muted. → Press the AUDIO MUTING key to release audio muting (page 38). • The sound is not adjusted properly. → Adjust the sound with the VOLUME +/- key on the Remote Commander.

Remote Commander

Symptom	Cause and Remedy
The Remote Commander does not work.	<ul style="list-style-type: none"> • The Remote Commander batteries are dead. → Replace them with new batteries (page 21). • The Remote Commander is not pointed at the sensor on the main unit. → Point the Remote Commander at the sensor on the main unit then press the key. • An invalid key is pressed. → Check if the pressed key is one inactive for this unit (page 20).

Others

Symptom	Cause and Remedy
The control panel keys do not function.	The control panel keys are locked. → Unlock the control panel keys (page 52).
The fan is noisy.	<ul style="list-style-type: none">• Lamp Mode is set to “High”. → When the Lamp Mode is set to “High”, the sound from the fan to cool the lamp, etc. is often excessive.• High Altitude Mode is set to “On”. → When High Altitude Mode is set to “On”, the sound from the fan to cool the lamp is often excessive. <p>→ Check the ventilation holes are not blocked.</p> <p>→ Make sure the room temperature is not too high. To maintain the product reliability of the projector’s components, the rotation speed of the fan increases and the fan becomes slightly noisier, when the room temperature exceeds normal. The approximate normal temperature is 25°C.</p>

Indicators

Symptom	Cause and Remedy
The LAMP/COVER indicator flashes in orange. (Repetition rate of 2 flashes)	<ul style="list-style-type: none"> The lamp cover is detached. <ul style="list-style-type: none"> → Attach the cover securely (page 58).
The LAMP/COVER indicator flashes in orange. (Repetition rate of 3 flashes)	<ul style="list-style-type: none"> The interior of the unit reached a high temperature, and the temperature sensor has been activated. <ul style="list-style-type: none"> → Check to see that nothing is blocking the fresh-air inlet and exhaust outlet. The lamp has reached a high temperature. <ul style="list-style-type: none"> → Wait for 90 seconds for the lamp to cool then turn on the power again. <p>After you have checked the items above, if any of the troubles recur, the following causes are possible:</p> <ul style="list-style-type: none"> The lamp must be replaced, because it has reached the end of its service life. The interior of the unit reached a high temperature, and the temperature fuse burned out. <ul style="list-style-type: none"> → Consult with qualified Sony personnel.
I/⏻ key flashes in red. (Repetition rate of 2 flashes)	<ul style="list-style-type: none"> The internal temperature is unusually high. <ul style="list-style-type: none"> → Check to see that nothing is blocking the ventilation holes. The projector is being used at a high altitude. <ul style="list-style-type: none"> → Ensure that “High Altitude Mode” in the Setup menu is set to “On.” (page 50)
I/⏻ key flashes in red. (Repetition rate of 4 flashes)	<p>The fan is broken.</p> <ul style="list-style-type: none"> → Consult with qualified Sony personnel.
I/⏻ key flashes in red. (Repetition rate of 6 flashes)	<p>Unplug the AC power cord from the wall outlet after the I/⏻ key goes out, plug the power cord to the wall outlet, and then turn the projector on again. If the I/⏻ key flashes in red and the problem persists, the electrical system has failed. Or the interior of the unit reached a high temperature, and the temperature fuse has burned out.</p> <ul style="list-style-type: none"> → Consult with qualified Sony personnel.

Messages List

Warning Messages

Use the list below to check the meaning of the messages displayed on the screen.

Message	Meaning and Remedy
High temp.! Lamp off in 1 min.	The internal temperature is too high. → Turn off the power. → Check to see that nothing is blocking the ventilation holes.
Frequency is out of range!	<ul style="list-style-type: none"> • This input signal cannot be projected as the frequency is out of the acceptable range of the projector. • The resolution setting of the output signal of the computer is too high. → Input a signal that is within the range of the frequency.
Please check Input-A Signal Sel.	You have input an RGB signal from the computer when “Input-A Signal Sel.” in the Setup menu is set to “Component.” → Set “Input-A Signal Sel.” correctly (page 51).
Please replace the Lamp.	<ul style="list-style-type: none"> • It is time to replace the lamp. → Replace the lamp (page 58). • If this message appears again after you replace the lamp, the lamp replacement process is not complete. → Perform the operations in step 9 to 12 on page 59. <p>Note To erase a message, press any key on the control panel of the projector or on the remote commander.</p>
Please clean the filter.	It is time to clean the filter. → Clean the filter (page 60). <p>Note To cancel the message, press any key on the remote commander or the control panel of the main unit. The message is displayed twice, including when the unit is started next time.</p>
Projector temperature is high. High Altitude Mode should be “On” if the projector is being used at high altitude.	Internal temperature is too high. → When using the projector at an altitude of 1,500 m or higher, set “High Altitude Mode” on the Setup menu to “On” (page 50). → If this message appears on the screen when using the projector at normal altitudes, check to see if anything is blocking the ventilation holes (exhaust) (page 17).

Caution Messages

Use the list below to check the meaning of the messages displayed on the screen.

Message	Meaning and Remedy
Not applicable!	You have pressed the wrong key. → Press the appropriate key.
The panel keys are locked!	“Panel Key Lock” in the Function menu is set to “On.” → All the keys on the control panel of the projector are locked. Operate the projector with the keys on the Remote Commander (page 52).

Specifications

Optical characteristics

Projection system	3 LCD panels, 1 lens, projection system
LCD panel	0.63-inch XGA panel, approximately 2,360,000 pixels (786,432 pixels × 3)
Lens	1.2 times zoom lens f 18.63 to 22.36 mm/F1.65 to 1.8
Lamp	200 W Ultra High Pressure mercury lamp
Projected picture size (measured diagonally)	40 to 300 inches
Light output	VPL-DX10: 2500 lumen VPL-DX11/DX15: 3000 lumen (When the Lamp Mode is set to "High.")

Electrical characteristics

Color system	NTSC _{3.58} /PAL/SECAM/ NTSC _{4.43} /PAL-M/PAL-N/ PAL60 system, switched automatically/manually (NTSC _{4.43} is the color system used when playing back a video recorded in NTSC on a NTSC _{4.43} system VCR.)
Resolution	750 horizontal TV lines (Video input) 1,024 × 768 dots (RGB input)
Acceptable computer signals ¹⁾	fH: 19 to 80 kHz fV: 48 to 92 Hz (Maximum input signal resolution: SXGA+ 1400 × 1050 fV: 60 Hz)

¹⁾ Set the resolution and the frequency of the signal of the connected computer within the range of acceptable preset signals of the projector.

Applicable video signals	15 k RGB, Component 50/60 Hz, Progressive component 50/60 Hz, DTV (480/60i, 575/50i, 480/60p, 575/50p, 720/60p, 720/50p, 1080/60i, 1080/50i), Composite video, Y/C
--------------------------	---

Input/Output

INPUT A	HD D-sub15-pin, female Analog RGB/component: R/R-Y: 0.7 Vp-p ±2 dB
---------	--

(75 ohms terminated)
G: 0.7 Vp-p ±2 dB
(75 ohms terminated)
G with sync/Y: 1 Vp-p ±2 dB
sync negative
(75 ohms terminated)
B/B-Y: 0.7 Vp-p ±2 dB
(75 ohms terminated)

Composite sync input: TTL level,
positive/negative
Horizontal sync input: TTL level,
Positive/negative
Vertical sync input: TTL level,
positive/negative

VIDEO
Composite video: 1 Vp-p ±2 dB
sync negative (75 ohms
terminated), Pin jack
S VIDEO: Y/C, mini DIN 4-pin
type
Y (luminance): 1 Vp-p ±2 dB
sync negative (75 ohms
terminated)

C (chrominance): burst
0.286 Vp-p ±2 dB (NTSC)
(75 ohms terminated),
burst 0.3 Vp-p ±2 dB (PAL)
(75 ohms terminated)

AUDIO
Minijack
500 mVrms, impedance more
than 47 kilohms
Speaker
Monaural speaker system,
Speaker output: Max. 1 W × 1
Network (VPL-DX15 only)
Wireless LAN:
IEEE.802.11.a/b/g²⁾
RJ-45: 10BASE-T/100BASE-TX

²⁾ Some wireless networks cannot be used in
certain countries or areas.

USB (VPL-DX15 only)
USB TYPE A

General

Dimensions	Approx. 295 × 74 × 204 mm (11 ⁵ / ₈ × 2 ²⁹ / ₃₂ × 8 ¹ / ₃₂ inches) (w/h/d) (without projecting parts)
Mass	VPL-DX10/DX11: Approx. 2.1 kg (4 lb 11 oz) VPL-DX15: Approx. 2.2 kg (4 lb 14 oz)
Power requirements	AC 100 V to 240 V, 3.6 to 1.6 A, 50/60 Hz

Power consumption
VPL-DX15: Max. 320 W
in standby (Standard): 10.5 W
in standby (Low): 3 W

VPL-DX10/DX11: Max. 320 W
 in standby (Standard): 5.5 W
 in standby (Low): 3 W

Heat dissipation

990 BTU

Operating temperature

0°C to 35°C (32°F to 95°F)

Operating humidity

35% to 85% (no condensation)

Storage temperature

-20°C to +60°C (-4°F to +140°F)

Storage humidity

10% to 90%

Supplied accessories

Remote Commander (1)

Lithium battery CR2025 (1)

HD D-sub 15 pin cable (2 m) (1)
 (1-791-992-51/Sony)

Carrying case (1)

AC power cord (1)

Operating Instructions (CD-ROM)
 (1)

Quick Reference Manual (1)

Safety Regulations (1)

Security Label (1)

Design and specifications of the unit, including the optional accessories, are subject to change without notice.

Note

Always verify that the unit is operating properly before use. SONY WILL NOT BE LIABLE FOR DAMAGES OF ANY KIND INCLUDING, BUT NOT LIMITED TO, COMPENSATION OR REIMBURSEMENT ON ACCOUNT OF THE LOSS OF PRESENT OR PROSPECTIVE PROFITS DUE TO FAILURE OF THIS UNIT, EITHER DURING THE WARRANTY PERIOD OR AFTER EXPIRATION OF THE WARRANTY, OR FOR ANY OTHER REASON WHATSOEVER.

Optional accessories

Projector Lamp

LMP-D200 (for replacement)

Presentation Tool

RM-PJPK1

Not all optional accessories are available in all countries and area.

Please check with your local Sony Authorized Dealer.

Pin assignment

INPUT A connector (HD D-sub 15-pin, female)

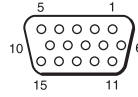

1	R/R-Y	9	Power supply input for DDC
2	G/Y	10	GND
3	B/B-Y	11	GND
4	GND	12	DDC/SDA
5	RESERVE	13	HD/C.Sync
6	GND (R)	14	VD
7	GND (G)	15	DDC/SCL
8	GND (B)		

Preset signals

Memory No.	Preset signal		fH (kHz)	fV (Hz)	Sync	Pitch
1	Video 60 Hz	Video 60 Hz	15.734	59.940	–	–
2	Video 50 Hz	Video 50 Hz	15.625	50.000	–	–
3	480/60i	DTV 480/60i	15.734	59.940	S on G/Y	–
4	575/50i	DTV 575/50i	15.625	50.000	S on G/Y	–
5	480/60p	480/60p (NTSC Progressive component)	31.470	60.000	S on G/Y	–
6	575/50p	575/50p (PAL Progressive component)	31.250	50.000	S on G/Y	–
7	1080/60i	1035/60i, 1080/60i	33.750	60.000	S on G/Y	–
8	1080/50i	1080/50i	28.130	50.000	S on G/Y	–
10	720/60p	720/60p	45.000	60.000	S on G/Y	–
11	720/50p	720/50p	37.500	50.000	S on G/Y	–
21	640 × 350	VGA mode 1	31.469	70.086	H-pos, V-neg	800
22		VESA 85 (VGA350)	37.861	85.080	H-pos, V-neg	832
23	640 × 400	NEC PC98	24.823	56.416	H-neg, V-neg	848
24		VGA mode 2	31.469	70.086	H-neg, V-pos	800
25		VESA 85 (VGA400)	37.861	85.080	H-neg, V-pos	832
26	640 × 480	VGA mode 3	31.469	59.940	H-neg, V-neg	800
27		Mac 13	35.000	66.667	H-neg, V-neg	864
28		VESA 72	37.861	72.809	H-neg, V-neg	832
29		VESA 75 (IBM M3)	37.500	75.000	H-neg V-neg	840
30		VESA 85	43.269	85.008	H-neg V-neg	832
31	800 × 600	VESA 56	35.156	56.250	H-pos, V-pos	1024
32		VESA 60	37.879	60.317	H-pos, V-pos	1056
33		VESA 72	48.077	72.188	H-pos, V-pos	1040
34		VESA 75 (IBM M5)	46.875	75.000	H-pos, V-pos	1056
35		VESA 85	53.674	85.061	H-pos, V-pos	1048
36	832 × 624	Mac 16	49.724	74.550	H-neg, V-neg	1152
37	1024 × 768	VESA 60	48.363	60.004	H-neg V-neg	1344
38		VESA 70	56.476	70.069	H-neg V-neg	1328
39		VESA 75	60.023	75.029	H-pos, V-pos	1312
40		VESA 85	68.677	84.997	H-pos, V-pos	1376

Memory No.	Preset signal		fH (kHz)	fV (Hz)	Sync	Pitch
41	1152 × 864	VESA 70	63.995	70.019	H-pos, V-pos	1472
42		VESA 75	67.500	75.000	H-pos, V-pos	1600
43		VESA 85	77.487	85.057	H-pos, V-pos	1568
44	1152 × 900	SUN LO	61.795	65.960	H-neg, V-neg	1504
45	1280 × 960	VESA 60	60.000	60.000	H-pos, V-pos	1800
46		VESA 75	75.000	75.000	H-pos, V-pos	1728
47	1280 × 1024	VESA 60	63.974	60.013	H-pos, V-pos	1688
48		SXGA VESA75	79.976	75.025	H-pos, V-pos	1688
50	1400 × 1050	SXGA+	65.317	59.978	H-neg, V-pos	1864
55	1280 × 768	1280 × 768/60	47.776	59.870	H-neg, V-pos	1664
56	1280 × 720	1280 × 720/60	44.772	59.855	H-neg, V-pos	1664
60	1360 × 768	1360 × 768/60	44.720	59.799	H-neg, V-pos	1776
61	1440 × 900	1440 × 900/60	55.935	59.887	H-neg, V-pos	1904
63	1280 × 800	1280 × 800/60	49.702	59.810	H-neg, V-pos	1680

Preset memory No. at the input signal

Analog signals

Signal	Preset memory No.
Video (VIDEO/S VIDEO connector)	1, 2
Component (INPUT A connector)	3-8, 10, 11
Video GBR (INPUT A connector)	3-8, 10, 11
Computer (INPUT A connector)	21-48, 50, 55, 56, 60, 61, 63

Notes

- When a signal other than the preset signals shown above is input, the picture may not be displayed properly.
- An input signal meant for screen resolution different from that of the panel will not be displayed in its original resolution. Text and lines may be uneven.
- When a moving image is played back from signals whose fV (Vertical Frequency) is over 60 Hz, the picture may not be displayed properly.

Installing the Projector and Installation Diagram

Floor Installation (Front Projection)

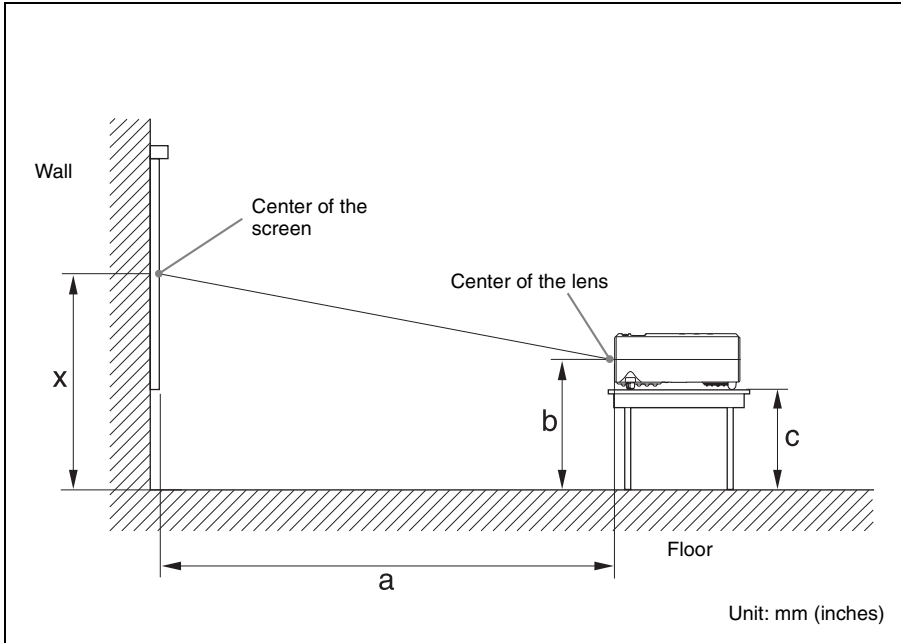

This section describes the examples of installing the projector on a desk, etc.

See the chart on page 71 concerning the installation measurements.

The alphabetical letters in the illustration indicate the distances below.

- a:** distance between the screen and the foremost side in cabinet
- b:** distance between the floor and the center of the lens
- c:** distance between the floor and the bottom of the adjusters of the projector
- x:** distance between the floor and the center of the screen (free)

PS		40	60	80	100	120	150	180	200	250	300
a	N	1160 (45 ¹¹ / ₁₆)	1758 (69 ⁷ / ₃₂)	2356 (92 ³ / ₄)	2954 (116 ⁹ / ₃₂)	3551 (139 ¹³ / ₁₆)	4448 (175 ¹ / ₈)	5345 (210 ⁷ / ₁₆)	5943 (233 ³¹ / ₃₂)	7437 (292 ¹³ / ₁₆)	8932 (351 ⁵ / ₈)
	M	1347 (53 ¹ / ₃₂)	2037 (80 ⁷ / ₃₂)	2728 (107 ¹³ / ₃₂)	3418 (134 ⁹ / ₁₆)	4109 (161 ³ / ₄)	5144 (202 ¹⁷ / ₃₂)	6180 (243 ⁵ / ₁₆)	6870 (270 ¹⁵ / ₃₂)	8596 (338 ⁷ / ₁₆)	10322 (406 ¹³ / ₃₂)
b		x-203 (x-8)	x-305 (x-12)	x-406 (x-16)	x-508 (x-20)	x-610 (x-24)	x-762 (x-30)	x-914 (x-36)	x-1016 (x-40)	x-1270 (x-50)	x-1524 (x-60)
c		x-252 (x-9 ²⁹ / ₃₂)	x-354 (x-13 ²⁹ / ₃₂)	x-455 (x-17 ²⁹ / ₃₂)	x-557 (x-21 ²⁹ / ₃₂)	x-658 (x-25 ²⁹ / ₃₂)	x-811 (x-31 ²⁹ / ₃₂)	x-963 (x-37 ²⁹ / ₃₂)	x-1065 (x-41 ²⁹ / ₃₂)	x-1319 (x-51 ²⁹ / ₃₂)	x-1573 (x-61 ²⁹ / ₃₂)

$$a (N) = \{(PS \times 18.46/0.6299) - 34.7\} \times 1.02$$

$$a (M) = \{(PS \times 22.19/0.6299) - 34.6\} \times 0.98$$

$$b = x - (PS/0.6299 \times 3.2)$$

$$c = x - (PS/0.6299 \times 3.2 + 48.7)$$

The alphabetical letters in the charts and calculation methods indicate the following.

PS: projected image size measured diagonally (inches)

a: distance between the screen and the foremost side in cabinet

b: distance between the floor and the center of the lens

c: distance between the floor and the adjusters of the projector

x: distance between the floor and the screen (free)

N: minimum

M: maximum

Ceiling Installation (Front Projection)

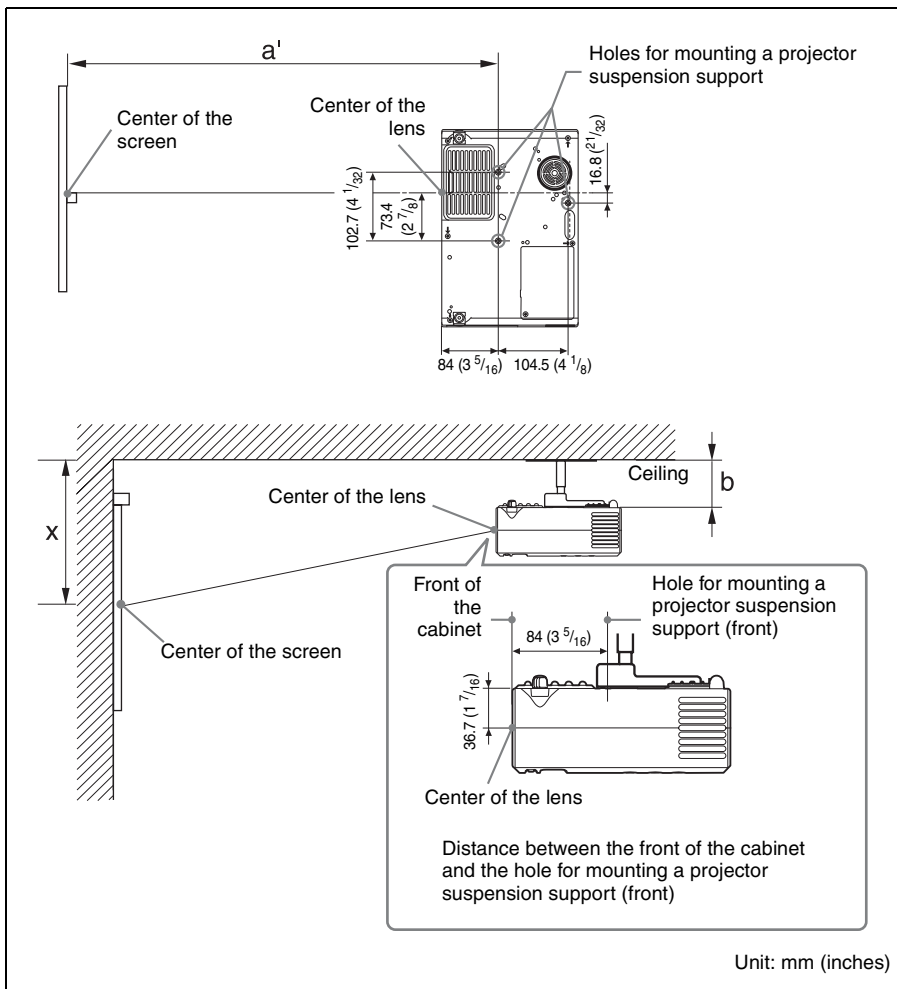

This section describes the examples for installing the projector on the ceiling.

When installing the projector on the ceiling, use a Projector Suspension Support recommended by Sony.

For ceiling installation, ask for qualified Sony personnel.

See the chart on page 73 concerning the installation measurements.

The alphabetical letters in the illustrations indicate the distances below.

a': distance between the hole(front) for mounting a projector suspension support on bottom surface of this projector and the center of the screen

b: distance between the projector suspension support mounting surface on bottom of this projector and the ceiling

x: distance between the ceiling and the center of the screen

PS	40	60	80	100	120	150	180	200	250	300	
a'	N	1244 (48 ³¹ / ₃₂)	1842 (72 ¹⁷ / ₃₂)	2440 (96 ¹ / ₁₆)	3038 (119 ¹⁹ / ₃₂)	3635 (143 ¹ / ₈)	4532 (178 ⁷ / ₁₆)	5429 (213 ²³ / ₃₂)	6027 (237 ⁹ / ₃₂)	7521 (296 ³ / ₃₂)	9016 (354 ¹⁵ / ₁₆)
	M	1431 (56 ¹¹ / ₃₂)	2121 (83 ¹⁷ / ₃₂)	2812 (110 ¹¹ / ₁₆)	3502 (137 ⁷ / ₈)	4193 (165 ¹ / ₁₆)	5228 (205 ²⁷ / ₃₂)	6264 (246 ¹⁹ / ₃₂)	6954 (273 ²⁵ / ₃₂)	8680 (341 ³ / ₄)	10406 (409 ¹¹ / ₁₆)
x	b + 240 (b+9 ⁷ / ₁₆)	b + 342 (b+13 ⁷ / ₁₆)	b + 443 (b+17 ⁷ / ₁₆)	b + 545 (b+21 ⁷ / ₁₆)	b + 646 (b+25 ⁷ / ₁₆)	b + 799 (b+31 ⁷ / ₁₆)	b + 951 (b+37 ⁷ / ₁₆)	b + 1053 (b+41 ⁷ / ₁₆)	b + 1307 (b+51 ⁷ / ₁₆)	b + 1561 (b+61 ⁷ / ₁₆)	
b	Free										

$$a'(N) = \{(PS \times 18.46/0.6299) - 34.7\} \times 1.02 + 84$$

$$a'(M) = \{(PS \times 22.19/0.6299) - 34.6\} \times 0.98 + 84$$

$$x = PS/0.6299 \times 3.2 + 36.7$$

The alphabetical letters in the charts and calculation methods indicate the following.

PS: projected image size measured diagonally (inches)

a': distance between the hole (front) for mounting a projector suspension support on bottom surface of this projector and the center of the screen

b: distance between the projector suspension support mounting surface on bottom of this projector and the ceiling

x: distance between the center of the screen and the ceiling

N: minimum

M: maximum

Dimensions

Front

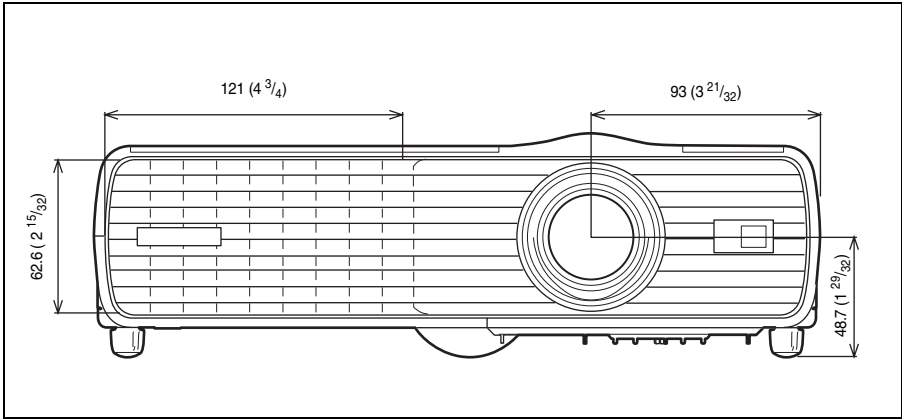

Unit: mm (inches)

Top

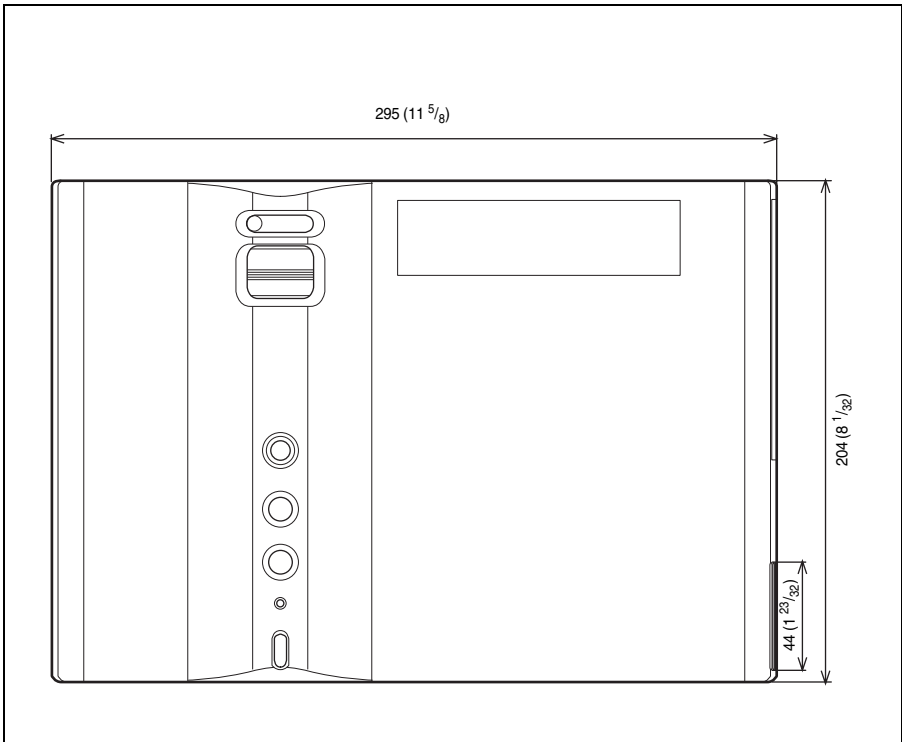

Unit: mm (inches)

Side

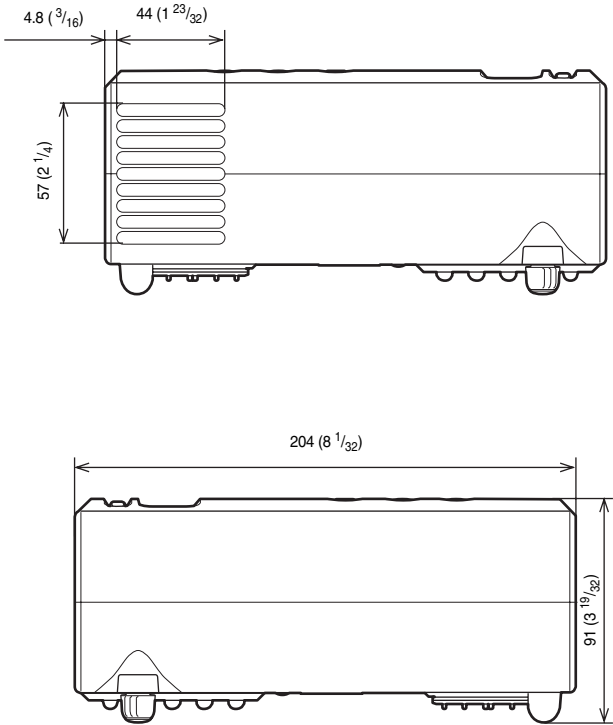

Others

Unit: mm (inches)

Rear

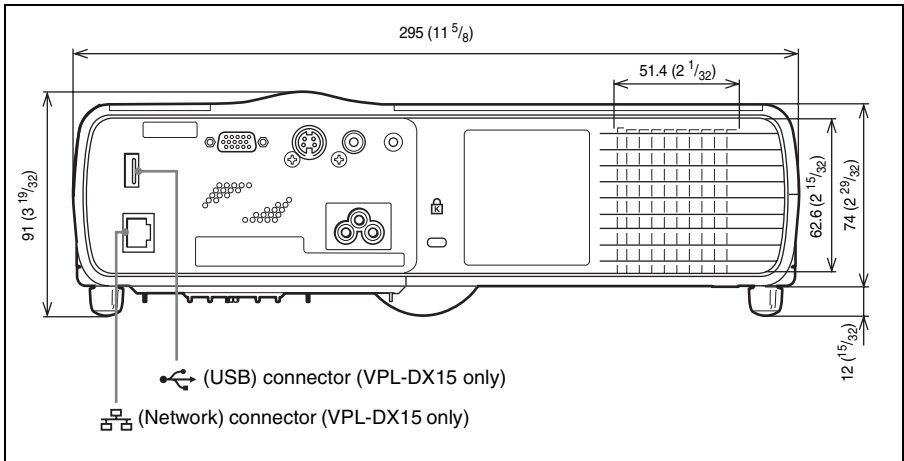

Unit: mm (inches)

Bottom

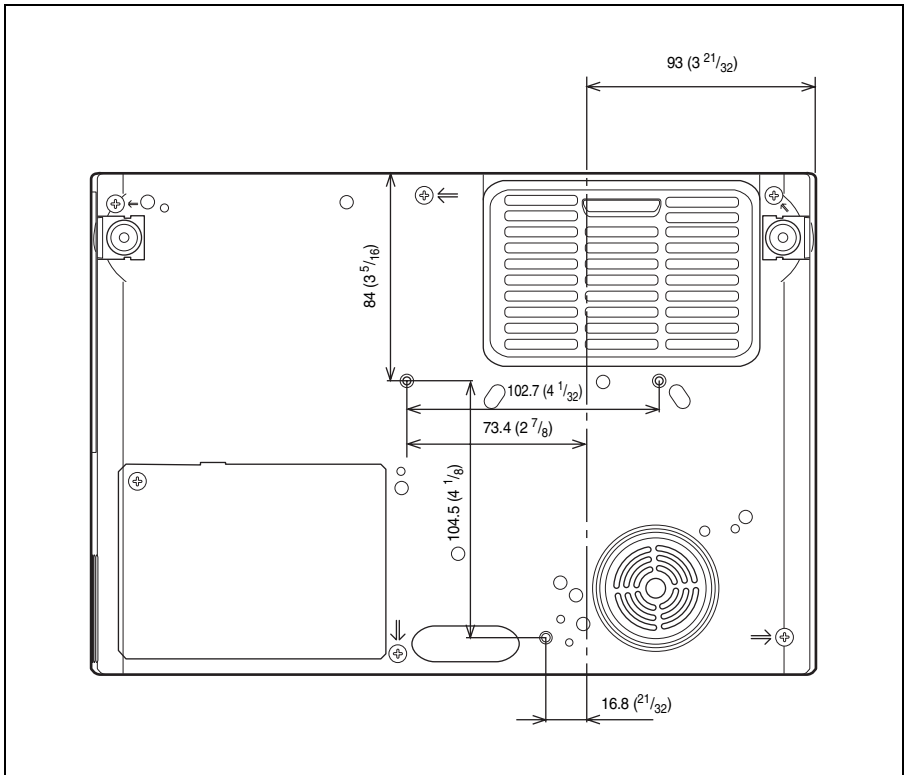

Unit: mm (inches)

Index

A

Adjust Signal	
APA	48
Phase	48
Pitch	48
Shift	48
Adjuster	26
Aspect	47
Audio muting	38
Auto Input Search	52

B

Background	52
Black Level Adj.	46
Brightness	45

C

Cleaning the air filter	60
Color	45
Color System	51
Color Temp.	46
Connecting a computer	23
Connecting a VCR	24
Contrast	45

D

DDE	46
Digital Zoom	36
Dimensions	74
Direct Power On	54

F

fH	56
Freeze	37
fV	56

G

Gamma Mode	46
------------------	----

H

High Altitude Mode	50
Hue	45

I

Image Flip	54
------------------	----

Input-A Signal Sel.	51
Installation Diagram	70
Floor Installation (Front Projection) ...	70
Installation diagram	
Ceiling installation	72
Installing the projector	22

L

Lamp Mode	54
Lamp Timer	56
Lamp Timer Reset	51
LAMP/COVER indicators	18
Language	50
Lens shutter	17, 37
Lens shutter lever	17
Location and function of controls	
Connector panel	19
Control panel	18
Rear/Side/Bottom	16
Top/Front/Side	16

M

Maintenance	58
Menu	
clearing the menu display	44
Function menu	52
Information menu	56
Installation menu	54
Network Setting menu	55
Picture menu	45
Screen menu	47
Setup menu	50
using a menu	43
Menu language	29
Messages list	
Caution messages	65
Warning messages	65

N

Network function	41
Network Setting	55

O

Off & Go	33
Optional accessories	67

P

Panel Key Lock	35, 52
Picture adjustment	45
Picture Mode	40, 45

Dynamic	45
Presentation	45
Standard	45
Picture muting	38
Pin assignment	67
Power	
turn on	25
Power Saving Mode	50
Precautions	10
Preset Memory No.	69
Preset signals	68

R

Remote Commander	20
Replacing the lamp	58
Reset	45

S

Screen size	66
Security lock (Mechanical)	17, 36
Security Lock (Password)	33, 53
Sharpness	46
Smart APA	39, 52
Specifications	66
Standby Mode	50
Start Up Image	50
Status	50
Storing the settings	44
Supplied accessories	67

T

Troubleshooting	61
-----------------------	----

U

USB file viewer	41
-----------------------	----

V

V Keystone	54
Ventilation holes (exhaust)	17
Ventilation holes (intake)	17
Volume	51

About Trademarks

- Adobe Acrobat is a trademark of Adobe Systems Incorporated.
- Windows is a registered trademark of Microsoft Corporation in the United States and/or other countries.
- Kensington is a registered trademark of Kensington Technology Group.
- Macintosh is a registered trademark of Apple Inc.
- VESA is a registered trademark of the Video Electronics Standards Association.
- Display Data Channel is a trademark of the Video Electronics Standards Association.
- All other trademarks and registered trademarks are trademarks or registered trademarks of their respective holders. In this manual, TM and ® marks are not specified.

